

Overview



Ultra flexible - with the universal SITRANS TR200 transmitter

- Two-wire devices for 4 to 20 mA
- Enclosure for rail mounting
- Universal input for virtually any type of temperature sensor
- Configurable over PC

Benefits

- Compact design
- Electrically isolated
- Test sockets for multimeters
- Diagnostics LED (green/red)
- Sensor monitoring open circuits and short-circuits
- Self-monitoring
- Configuration status stored in EEPROM
- Expanded diagnostic functions, such as slave pointer, operating hours counter, etc.
- Special characteristic
- Electromagnetic compatibility to EN 61326 and NE21
- SIL2 (with Order code C20), SIL2/3 (with C23)

Application

SITRANS TR200 transmitters can be used in all industrial sectors. Their compact design enables simple mounting on standard DIN rails on-site in protective boxes or in control cabinets. The following sensors/signal sources can be connected over their universal input module:

- Resistance thermometers (2, 3 or 4-wire system)
- Thermocouples
- Resistance-based sensors and DC voltage sources

The output signal is a direct current from 4 to 20 mA in accordance with the sensor characteristic.

Transmitters of the "intrinsically safe" type of protection can be installed within potentially explosive atmospheres. The devices comply with the Directive 2014/34/EU (ATEX).

Function

The SITRANS TR200 is configured over a PC. A USB or RS 232 modem is linked to the output terminals for this purpose. The configuration data can now be edited using the SIPROM T software tool. The configuration data are then permanently stored in the non-volatile memory (EEPROM).

Once the sensors and power supply have been correctly connected, the transmitter outputs a temperature-linear output signal and the diagnostics LED displays a green light. In the case of a sensor short-circuit, the LED flashes red, an internal device fault is indicated by a steady red light.

The test socket can be used to connect an ammeter at any time for monitoring purposes and plausibility checks. The output current can be read without any interruption, or even without opening the current loop.

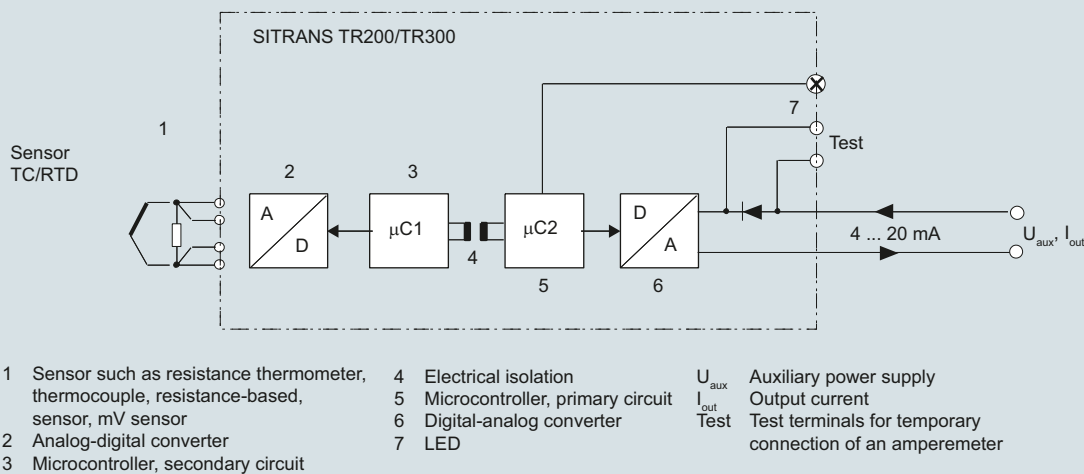

SITRANS TR200 function diagram

Temperature Measurement

Transmitters for rail mounting

SITRANS TR200, two-wire system, Universal

Technical specifications

Input

Resistance thermometer

Measured variable	Temperature
Sensor type	<ul style="list-style-type: none"> to IEC 60751 Pt25 ... 1000 to JIS C 1604; $a=0.00392 \text{ K}^{-1}$ Pt25 ... 1000 to IEC 60751 Ni25 ... 1000 Special type over special characteristic (max. 30 points)
Sensor factor	0.25 ... 10 (adaptation of the basic type, e.g. Pt100 to version Pt25 ... 1000)
Units	°C or °F
Connection	<ul style="list-style-type: none"> Standard connection 1 resistance thermometer (RTD) in 2-wire, 3-wire or 4-wire system Generation of average value 2 resistance thermometers in 2-wire system for generation of average temperature Generation of difference 2 resistance thermometers (RTD) in 2-wire system (RTD 1 – RTD 2 or RTD 2 – RTD 1)
Interface	<ul style="list-style-type: none"> Two-wire system Parameterizable line resistance $\leq 100 \Omega$ (loop resistance) Three-wire system No balancing required Four-wire system No balancing required
Sensor current	$\leq 0.45 \text{ mA}$
Response time T_{63}	$\leq 250 \text{ ms}$ for 1 sensor with open-circuit monitoring
Open-circuit monitoring	Always active (cannot be disabled)
Short-circuit monitoring	can be switched on/off (default value: ON)
Measuring range	parameterizable (see table "Digital measuring errors")
Min. measured span	10 °C (18 °F)
Characteristic curve	Temperature-linear or special characteristic

Resistance-based sensors

Measured variable	Actual resistance
Sensor type	Resistance-based, potentiometers
Units	Ω
Connection	<ul style="list-style-type: none"> Normal connection 1 resistance-based sensor (R) in 2-wire, 3-wire or 4-wire system Generation of average value 2 resistance-based sensors in 2-wire system for generation of average value Generation of difference 2 resistance thermometers in 2-wire system (R1 – R2 or R2 – R1)
Interface	<ul style="list-style-type: none"> Two-wire system Parameterizable line resistance $\leq 100 \Omega$ (loop resistance) Three-wire system No balancing required Four-wire system No balancing required
Sensor current	$\leq 0.45 \text{ mA}$
Response time T_{63}	$\leq 250 \text{ ms}$ for 1 sensor with open-circuit monitoring
Open-circuit monitoring	Always active (cannot be disabled)

Short-circuit monitoring	can be switched on/off (default value: OFF)
Measuring range	parameterizable max. 0 ... 2200 Ω (see table "Digital measuring errors")
Min. measured span	5 ... 25 Ω (see table "Digital measuring errors")
Characteristic curve	Resistance-linear or special characteristic
<u>Thermocouples</u>	
Measured variable	Temperature
Sensor type (thermocouples)	<ul style="list-style-type: none"> Type B Pt30Rh-Pt6Rh to DIN IEC 584 Type C W5 %-Re acc. to ASTM 988 Type D W3 %-Re acc. to ASTM 988 Type E NiCr-CuNi to DIN IEC 584 Type J Fe-CuNi to DIN IEC 584 Type K NiCr-Ni to DIN IEC 584 Type L Fe-CuNi to DIN 43710 Type N NiCrSi-NiSi to DIN IEC 584 Type R Pt13Rh-Pt to DIN IEC 584 Type S Pt10Rh-Pt to DIN IEC 584 Type T Cu-CuNi to DIN IEC 584 Type U Cu-CuNi to DIN 43710
Units	°C or °F
Connection	<ul style="list-style-type: none"> Standard connection 1 thermocouple (TC) Generation of average value 2 thermocouples (TC) Generation of difference 2 thermocouples (TC) (TC1 – TC2 or TC2 – TC1)
Response time T_{63}	$\leq 250 \text{ ms}$ for 1 sensor with open-circuit monitoring
Open-circuit monitoring	Can be switched off
Cold junction compensation	<ul style="list-style-type: none"> Internal With integrated Pt100 resistance thermometer External With external Pt100 IEC 60751 (2-wire or 3-wire connection) External fixed Cold junction temperature can be set as fixed value
Measuring range	parameterizable (see table "Digital measuring errors")
Min. measured span	Min. 40 ... 100 °C (72 ... 180 °F) (see table "Digital measuring errors")
Characteristic curve	Temperature-linear or special characteristic
<u>mV sensor</u>	
Measured variable	DC voltage
Sensor type	DC voltage source (DC voltage source possible over an externally connected resistor)
Units	mV
Response time T_{63}	$\leq 250 \text{ ms}$ for 1 sensor with open-circuit monitoring
Open-circuit monitoring	Can be switched off
Measuring range	parameterizable max. -100 ... 1100 mV
Min. measured span	2 mV or 20 mV
Overload capability of the input	-1.5 ... +3.5 V DC
Input resistance	$\geq 1 \text{ M}\Omega$
Characteristic curve	Voltage-linear or special characteristic

Output	
Output signal	4 ... 20 mA, 2-wire
Auxiliary power	11 ... 35 V DC (to 30 V for Ex i/ic; to 32 V for Ex nA)
Max. load	($U_{aux} - 11$ V)/0.023 A
Overrange	3.6 ... 23 mA, infinitely adjustable (default range: 3.84 mA ... 20.5 mA)
Error signal (e.g. following sensor fault) (conforming to NE43)	3.6 ... 23 mA, infinitely adjustable (default value: 22.8 mA)
Sample cycle	0.25 s nominal
Damping	Software filter 1st order 0 ... 30 s (parameterizable)
Protection	Against reversed polarity
Electrically isolated	Input against output 2.12 kV DC (1.5 kV _{eff} AC)

Measuring accuracy	
Digital measuring errors	See Table "Digital measuring errors"
Reference conditions	
• Auxiliary power	24 V ± 1 %
• Load	500 Ω
• Ambient temperature	23 °C
• Warming-up time	> 5 min
Error in the analog output (digital/analog converter)	< 0.025 % of span
Error due to internal cold junction	< 0.5 °C (0.9 °F)
Influence of ambient temperature	
• Analog measuring error	0.02 % of span/10 °C (18 °F)
• Digital measuring errors	
- With resistance thermometer	0.06 °C (0.11 °F)/10 °C (18 °F)
- with thermocouples	0.6 °C (1.1 °F)/10 °C (18 °F)
Auxiliary power effect	< 0.001 % of span/V
Effect of load impedance	< 0.002 % of span/100 Ω
Long-term drift	
• In the first month	< 0.02 % of span in the first month
• After one year	< 0.2 % of span after one year
• After 5 years	< 0.3 % of span after 5 years

Conditions of use	
<u>Ambient conditions</u>	
Ambient temperature range	-40 ... +85 °C (-40 ... +185 °F)
Storage temperature range	-40 ... +85 °C (-40 ... +185 °F)
Relative humidity	< 98 %, with condensation
Electromagnetic compatibility	acc. to EN 61326 and NE21

Construction	
Material	Plastic, electronic module potted
Weight	122 g
Dimensions	See "Dimensional drawings"
Cross-section of cables	Max. 2.5 mm ² (AWG 13)
Degree of protection to IEC 60529	
• Enclosure	IP20

Certificates and approvals	
Explosion protection ATEX	
EC type test certificate	PTB 07 ATEX 2032X
• "Intrinsic safety" type of protection	II 2(1) G Ex ia/ib IIC T6/T4 II 3(1) G Ex ia/ic IIC T6/T4 II 3 G Ex ic IIC T6/T4 II 2(1) D Ex iaD/ibD 20/21 T115 °C
• Type of protection, "equipment is non-arcing"	II 3 G Ex nA IIC T6/T4
Other certificates	NEPSI and EAC Ex
Software requirements for SIPROM T	
PC operating system	Windows ME, 2000, XP, Win 7 and Win 8; can also be used in connection with RS 232 modem under Windows 95, 98 and 98SE

Factory setting:

- Pt100 (IEC 751) with 3-wire circuit
- Measuring range: 0 ... 100 °C (32 ... 212 °F)
- Error signal in the event of sensor breakage: 22.8 mA
- Sensor offset: 0 °C (0 °F)
- Damping 0.0 s

Digital measuring errors

Resistance thermometer

Input	Measuring range °C/(°F)	Min. measured span		Digital accuracy	
		°C	(°F)	°C	(°F)
to IEC 60751					
Pt25	-200 ... +850 (-328 ... +1562)	10	(18)	0.3	(0.54)
Pt50	-200 ... +850 (-328 ... +1562)	10	(18)	0.15	(0.27)
Pt100 ... Pt200	-200 ... +850 (-328 ... +1562)	10	(18)	0.1	(0.18)
Pt500	-200 ... +850 (-328 ... +1562)	10	(18)	0.15	(0.27)
Pt1000	-200 ... +350 (-328 ... +662)	10	(18)	0.15	(0.27)
to JIS C1604-81					
Pt25	-200 ... +649 (-328 ... +1200)	10	(18)	0.3	(0.54)
Pt50	-200 ... +649 (-328 ... +1200)	10	(18)	0.15	(0.27)
Pt100 ... Pt200	-200 ... +649 (-328 ... +1200)	10	(18)	0.1	(0.18)
Pt500	-200 ... +649 (-328 ... +1200)	10	(18)	0.15	(0.27)
Pt1000	-200 ... +350 (-328 ... +662)	10	(18)	0.15	(0.27)
Ni 25 ... Ni1000	-60 ... +250 (-76 ... +482)	10	(18)	0.1	(0.18)

Temperature Measurement

Transmitters for rail mounting

SITRANS TR200, two-wire system, Universal

Resistance-based sensors

Input	Measuring range	Min. measured span	Digital accuracy
	Ω	Ω	Ω
Resistance	0 ... 390	5	0.05
Resistance	0 ... 2200	25	0.25

Thermocouples

Input	Measuring range	Min. measured span		Digital accuracy	
	$^{\circ}\text{C}/(^{\circ}\text{F})$	$^{\circ}\text{C}$	$(^{\circ}\text{F})$	$^{\circ}\text{C}$	$(^{\circ}\text{F})$
Type B	100 ... 1820 (212 ... 3308)	100	(180)	2 ¹⁾	(3.6) ¹⁾
Type C (W5)	0 ... 2300 (32 ... 4172)	100	(180)	2	(3.6)
Type D (W3)	0 ... 2300 (32 ... 4172)	100	(180)	1 ²⁾	(1.8) ²⁾
Type E	-200 ... +1000 (-328 ... +1832)	50	(90)	1	(1.8)
Type J	-200 ... +1200 (-328 ... +2192)	50	(90)	1	(1.8)
Type K	-200 ... +1370 (-328 ... +2498)	50	(90)	1	(1.8)
Type L	-200 ... +900 (-328 ... +1652)	50	(90)	1	(1.8)
Type N	-200 ... +1300 (-328 ... +2372)	50	(90)	1	(1.8)
Type R	-50 ... +1760 (-58 ... +3200)	100	(180)	2	(3.6)
Type S	-50 ... +1760 (-58 ... +3200)	100	(180)	2	(3.6)
Type T	-200 ... +400 (-328 ... +752)	40	(72)	1	(1.8)
Type U	-200 ... +600 (-328 ... +1112)	50	(90)	2	(3.6)

¹⁾ The digital accuracy in the range 100 to 300 °C (212 to 572 °F) is 3 °C (5.4 °F).

²⁾ The digital accuracy in the range 1750 to 2300 °C (3182 to 4172 °F) is 2 °C (3.6 °F).

mV sensor

Input	Measuring range	Min. measured span	Digital accuracy
	mV	mV	μV
mV sensor	-10 ... +70	2	40
mV sensor	-100 ... +1100	20	400

The digital accuracy is the accuracy after the analog/digital conversion including linearization and calculation of the measured value.

An additional error is generated in the output current 4 to 20 mA as a result of the digital/analog conversion of 0.025 % of the set span (digital-analog error).

The total error under reference conditions at the analog output is the sum from the digital error and the digital-analog error (poss. with the addition of cold junction errors in the case of thermocouple measurements).

Temperature Measurement

Transmitters for rail mounting

SITRANS TR200, two-wire system, Universal

Selection and Ordering data	Article No.
Temperature transmitter SITRANS TR200	
For mounting on a standard DIN rail, two-wire system, 4 to 20 mA, programmable, with electrical isolation	
<ul style="list-style-type: none"> Without explosion protection With explosion protection to ATEX 	7NG3032-0JN00 7NG3032-1JN00
Further designs	Order code
Please add "-Z" to Article No. with and specify Order codes(s).	
With test protocol (5 measuring points)	C11
Functional safety SIL2	C20
Functional safety SIL2/3	C23
Customer-specific programming	
Add "-Z" to Article No. and specify Order code(s)	
Measuring range to be set Specify in plain text (max. 5 digits): Y01: ... to ... °C, °F	Y01¹⁾
Measuring point no. (TAG), max. 8 characters	Y17²⁾
Measuring point descriptor, max. 16 characters	Y23²⁾
Measuring point message, max. 32 characters	Y24²⁾
Text on front label, max. 16 characters	Y29²⁾³⁾
Pt100 (IEC) 2-wire, $R_L = 0 \Omega$	U02⁴⁾
Pt100 (IEC) 3-wire	U03⁴⁾
Pt100 (IEC) 4-wire	U04⁴⁾
Thermocouple type B	U20⁴⁾⁵⁾
Thermocouple type C (W5)	U21⁴⁾⁵⁾
Thermocouple type D (W3)	U22⁴⁾⁵⁾
Thermocouple type E	U23⁴⁾⁵⁾
Thermocouple type J	U24⁴⁾⁵⁾
Thermocouple type K	U25⁴⁾⁵⁾
Thermocouple type L	U26⁴⁾⁵⁾
Thermocouple type N	U27⁴⁾⁵⁾
Thermocouple type R	U28⁴⁾⁵⁾
Thermocouple type S	U29⁴⁾⁵⁾
Thermocouple type T	U30⁴⁾⁵⁾
Thermocouple type U	U31⁴⁾⁵⁾
With TC: CJC external (Pt100, 3-wire)	U41
With TC: CJC external with fixed value, specify in plain text	Y50
Special differing customer-specific programming, specify in plain text	Y09⁶⁾
Fail-safe value 3.6 mA (instead of 22.8 mA)	U36²⁾

Accessories

Further accessories for assembly, connection and transmitter configuration, see page 2/238.

Modem for SITRANS TH100, TH200, TR200 and TF with TH200 incl. SIPROM T parameterization software

With USB connection

Article No.

7NG3092-8KN

- For customer-specific programming for RTD and TC, the start value and the end value of the required measuring span must be specified here.
- For this selection, Y01 or Y09 must also be selected.
- Text on front plate is not saved in the device.
- For this selection, Y01 must also be selected.
- Internal cold junction compensation is selected as the default for TC.
- For customer-specific programming, for example mV and ohm, the start value and the end value of the required measuring span and the unit must be entered here.

Supply units see Chapter "Supplementary Components".

Ordering example 1:

7NG3032-0JN00-Z Y01+Y17+Y29+U03
 Y01: -10 ... +100 °C
 Y17: TICA123
 Y29: TICA123

Ordering example 2:

7NG3032-0JN00-Z Y01+Y17+Y23+Y29+U25
 Y01: -10 ... +100 °C
 Y17: TICA123
 Y23: TICA123HEAT
 Y29: TICA123HEAT

Factory setting:

- Pt100 (IEC 751) with 3-wire circuit
- Measuring range: 0 ... 100 °C (32 ... 212 °F)
- Fault current: 22.8 mA
- Sensor offset: 0 °C (0 °F)
- Damping 0.0 s

Temperature Measurement

Transmitters for rail mounting

SITRANS TR200, two-wire system, Universal

Dimensional drawings

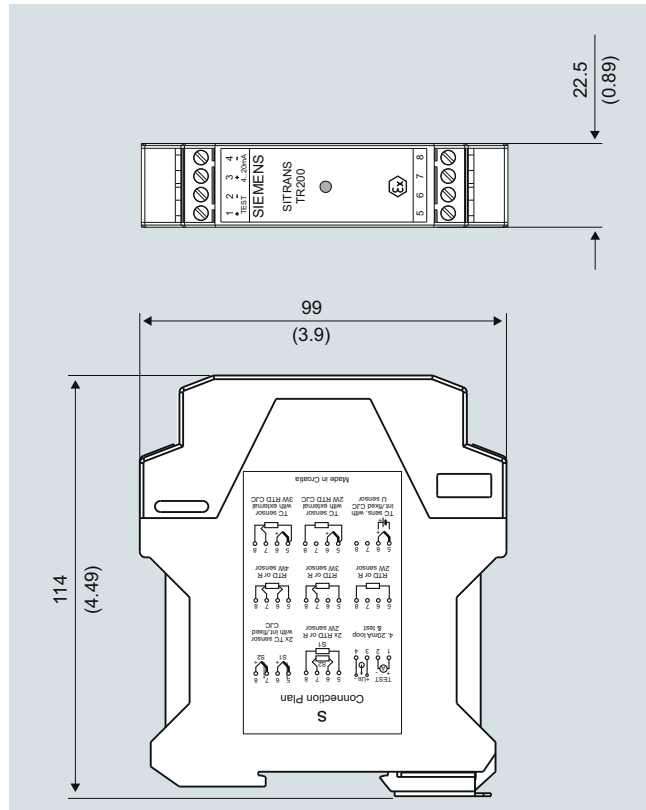

SITRANS TR200, dimensions in mm (inch)

Schematics

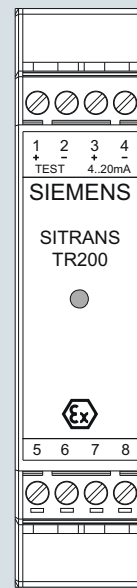

Assignments

- | | |
|-----------------|---|
| 1 (+) and 2 (-) | Test terminals (test) for measurement of the output current with a multimeter |
| 3 (+) and 4 (-) | Power supply U_{aux} , output current I_{out} |
| 5, 6, 7 and 8 | Sensor assignment, see schematics |

SITRANS TR200, pin assignment

Resistance thermometer

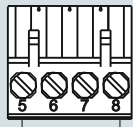

Two-wire system ¹⁾

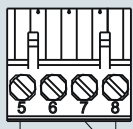

Three-wire system

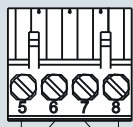

Four-wire system

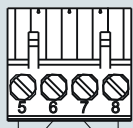

Generation of average value/difference ¹⁾

¹⁾ Programmable line resistance for the purpose of correction.

Resistance

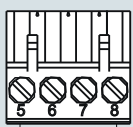

Two-wire system ¹⁾

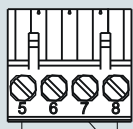

Three-wire system

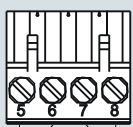

Four-wire system

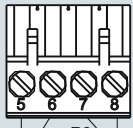

Generation of average value/difference ¹⁾

Thermocouple

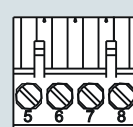

Cold junction compensation internal/fixed value

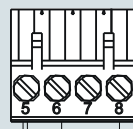

Cold junction compensation with external Pt100 in two-wire system ¹⁾

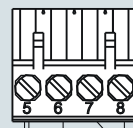

Cold junction compensation with external Pt100 in three-wire system

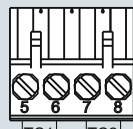

Generation of average value / difference with internal cold junction compensation

Voltage measurement

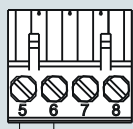

Current measurement

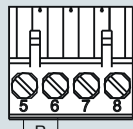

Test terminals

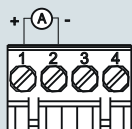

Power supply/ 4 ... 20 mA (U_{aux})

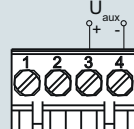

SITRANS TR200, sensor connection assignment