

Flow Measurement

SITRANS F M

Flow sensor MAG 1100 F

Overview



The electromagnetic sensor SITRANS F M MAG 1100 F is designed to meet applications in the food and beverage industry.

Benefits

- Sensor sizes: DN 10 to DN 100 (3/8" to 4")
- AISI 316 stainless steel enclosure
- Sensor: Hygienic connection, 3A approval and EHEDG certified
- Sanitary design for CIP / SIP cleaning
- Easy commissioning, the SENSORPROM unit automatically updates settings
- Hose proof IP67/NEMA 4X enclosure rating
- Designed that patented in-situ verification can be conducted. Using SENSORPROM fingerprints

Application

The main applications of the SITRANS F M electromagnetic sensors can be found in the following fields:

- Food industry
- Beverage industry
- Pharmaceutical industry

Design

- Unique mechanical design with a wide range of customer specified sanitary connection
- Compact or remote mounting possible easy "plug & play" field changeable
- Simple on site upgrade to IP68/NEMA 6P terminal box
- ATEX 2G D version for hazardous areas (ceramic liner)

Mode of operation

The flow measuring principle is based on Faraday's law of electromagnetic induction according to which the sensor converts the flow into an electrical voltage proportional to the velocity of the flow.

Integration

The complete flowmeter consists of a sensor and an associated transmitter SITRANS F M MAG 5000, 6000 and 6000 I. The flexible communication concept USM II simplifies integration and update to a variety of fieldbus systems such as PROFIBUS DP and PA, Modbus RTU/RS 485, HART, FOUNDATION Fieldbus H1, DeviceNet.

Pressure/temperature curve; material AISI 316L/1.4404

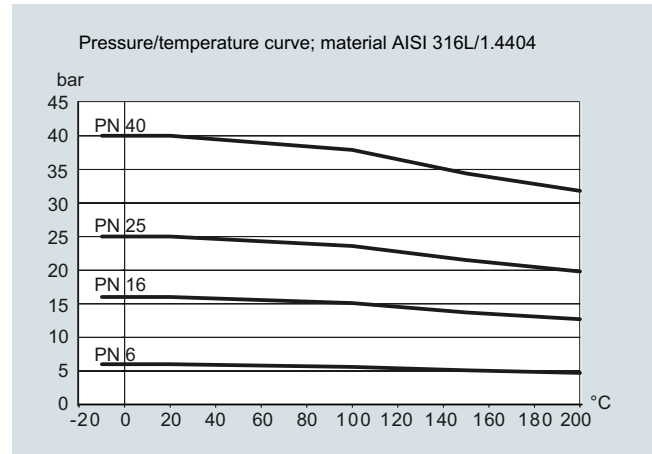

Pressure/temperature curve; material AISI 316L/1.4404

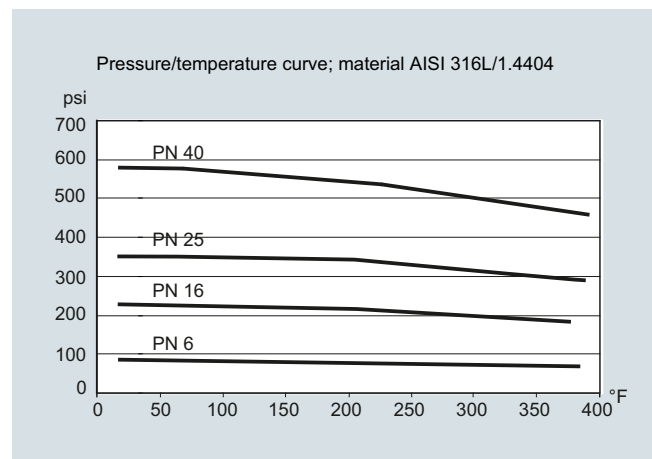

For further information on the PED standard and requirements, see page 10/15.

Technical specifications

Measuring principle	Electromagnetic induction	
Excitation frequency (Mains supply: 50 Hz/60 Hz)	DN 10 ... 65 (¼" ... 2½"): 12.5 Hz/15 Hz DN 80 ... 100 (3", 4"): 6.25 Hz/7.5 Hz	
Process connection		
Nominal size	DN 10 ... DN 100 (3/8" ... 4")	
Process connection	Hygienic adapters available for: <ul style="list-style-type: none"> • Direct welding onto pipe • Clamp fitting • Threaded fitting 	
Rated operating conditions		
<u>Ambient conditions</u>		
Ambient temperature		
• Sensor	-40 ... +100 °C (-40 ... +212 °F)	
• Ex sensor	-20 ... +60 °C (-4 ... +140 °F)	
• Compact with transmitter MAG 5000/6000	-20 ... +60 °C (-4 ... +140 °F)	
• Compact with transmitter MAG 6000 I	-20 ... +60 °C (-4 ... +140 °F)	
• Compact with transmitter MAG 6000 I Ex	-20 ... +60 °C (-4 ... +140 °F)	
<u>Temperature of medium</u>		
MAG 1100 F (Ceramic)	-20 ... +150 °C (-4 ... +302 °F) Suitable for steam sterilization	
MAG 1100 F (PFA)	-30 ... +130 °C (-22 ... +266 °F) Suitable for steam sterilization at 150 °C (302 °F)	
<u>Temperature shock</u>		
MAG 1100 F		
• Duration ≤ 1 min, followed by 10 min rest	<ul style="list-style-type: none"> • DN 10, 15, 25: Max. $\Delta T \leq 80$ °C/min (3/8", ½", 1"): Max. $\Delta T \leq 144$ °F/min • DN 40, 50, 65: Max. $\Delta T \leq 70$ °C/min (1½", 2", 2½"): Max. $\Delta T \leq 126$ °F/min • DN 80, 100: Max. $\Delta T \leq 60$ °C/min (3", 4"): Max. $\Delta T \leq 108$ °F/min 	
MAG 1100 F (PFA)	Max. ± 100 °C (212 °F) momentarily	
<u>Operating pressure</u>		
MAG 1100 F (Ceramic)	DN 10 ... 65: 40 bar (3/8" ... 2½"): 580 psi) DN 80: 25 bar (3": 363 psi) DN 100: 25 bar (4": 363 psi) Vacuum: 1×10^{-6} bar _{abs} (1.5×10^{-5} psi _{abs})	
MAG 1100 F (PFA)	20 bar (290 psi) Vacuum: 0.02 bar _{abs} (0.3 psi _{abs}) DN 80 ... DN 100: CO ₂ pressure max. 7 bar (101.5 psi)	
<u>Mechanical load (vibration)</u>		
	18 ... 1000 Hz random in x, y z, directions for 2 hours according to EN 60068-2-36	
	Sensor: 3.17 g RMS	
	Sensor with compact MAG 5000/ 6000 mounted transmitter: 3.17 g RMS.	
	Sensor with compact MAG 6000 I/MAG 6000 I Ex mounted transmitter: 1.14 g RMS	
	For compact installation with the MAG 6000 I/MAG 6000 I Ex, trans- mitter to be supported to avoid tension on sensor part.	
<u>Enclosure rating</u>		
EMC	IP67 to EN 60529 (NEMA 4X), 1 mH ₂ O for 30 min	
	2014/30/EU	
Design		
Weight		See Dimensional drawings
<u>Material</u>		
Enclosure		
• MAG 1100 F		Stainless steel AISI 316L/1.4404
Terminal box (remote version only)		
• Standard		Fibre glass reinforced polyamide Stainless steel AISI 316/1.4436
• Option		
• Ex ATEX (remote version only)		Stainless steel AISI 316/1.4436
Liner		
MAG 1100 F (Ceramic)		Aluminum oxide Al ₂ O ₃ (ceramics)
MAG 1100 F (PFA)		Reinforced PFA (teflon) (not for Ex)
Electrodes		
MAG 1100 F (Ceramic)		Platinum with gold /Titanium brazing alloy
MAG 1100 F (PFA)		<ul style="list-style-type: none"> • DN 10 ... 15 (3/8" ... ½"): Hastelloy C276/2.4819 • DN 25 ... 100 (1" ... 4"): Hastelloy C22/2.4602
Cable entries		
		<ul style="list-style-type: none"> • Remote installation 2 x M20 or 2 x ½" NPT • Compact installation <ul style="list-style-type: none"> - MAG 5000/MAG 6000: 4 x M20 or 4 x ½" NPT - MAG 6000 I: 2 x M25 (for sup- ply/output) - MAG 6000 I Ex: 2 x M25 (for supply/output)
Certificates and approvals		
Calibration		
• Standard production calibration		Zero-point, 2 x 25 %, 2 x 90 %
Hazardous area		
• MAG 1100 F (Ceramic)		
- Ex-sensor in compact or remote version with MAG 6000 I Ex		ATEX, EAC Ex - Zone 1 Ex d e ia IIB T6 Gb ATEX - Zone 21 Ex tD A21 IP67
- Standard sensor in compact or remote version with MAG 5000/6000/6000 I		FM - NI Class I Div. 2 Groups A, B, C, D
MAG 1100 F (PFA)		
- Standard sensor in compact or remote version with MAG 5000/6000/6000 I		FM - NI Class I Div. 2 Groups A, B, C, D
Hygienic		
• MAG 1100 F (Ceramic)		3A (remote version with Polyam- ide terminal box)
• MAG 1100 F (PFA)		3A (remote version with Polyam- ide terminal box) EHEDG (remote version with Poly- amide terminal box, DN 25 ... 100/1 ... 4") Hygienic EC 1935:2004 European food contact material
Pressure Equipment		PED - 2014/68/EU
Others		EAC (Russia, Belarus, Kazakhstan) KCC (South Korea)

Flow Measurement

SITRANS F M

Flow sensor MAG 1100 F

Accessories

Weld-in adapter

Adapter for welding onto dairy pipe, stainless steel 1.4404

- DN 10, 15, 25, 40, 50 and 65 (3/8", 1/2", 1", 1 1/2", 2" and 2 1/2")
- DN 80 and DN 100 (3" and 4")

Tri-Weld, ISO 2037, DIN 11850, SMS 3008, BS 4825-1

PN 40 (600 psi)

PN 25 (350 psi)

Clamp adapter

DN 10, 15, 25, 40 and 50 (3/8", 1/2", 1", 1 1/2", and 2")

DN 65, 80 and 100 (2 1/2", 3" and 4")

Tri-Clamp, ISO 2852, DIN 32676, SMS 3016, BS 4825-3

PN 16 (200 psi)

PN 10 (150 psi)

Thread adapter

DIN 11851

- DN 10, 15, 25, and 40 (3/8", 1/2", 1", and 1 1/2")

PN 40 (600 psi)

- DN 50, 65, 80 and 100 (2", 2 1/2", 3" and 4")

PN 25 (350 psi)

ISO 2853, BS 4825-4

- DN 10, 15, 25, 40, 50, 65 and 80 (3/8", 1/2", 1", 1 1/2", 2", 2 1/2" and 3")

PN 16 (200 psi)

SMS 1145

- DN 25, 40, 50, 65 and 80 (1", 1 1/2", 2", 2 1/2" and 3")

PN 6 (80 psi)

Design

Material

Adapter

Stainless steel AISI 316/1.4436

Gasket

- MAG 1100 F (Ceramic)

FKM/FPM with stainless steel insert (AISI 304/1.4301) (-20 ... +150 °C (-4 ... +302 °F))

EPDM (-20 ... +150 °C (-4 ... +302 °F))

- MAG 1100 F (PFA)

EPDM (-20 ... +150 °C (-4 ... +302 °F))

NBR (-20 ... +100 °C (-4 ... +212 °F))

Note:

When combined sensor and adapter, the operating pressure is the lower rated of the pair.

Selection and Ordering data

Sensor SITRANS F M MAG 1100 F

Article No.

7 ME 6 1 4 0 -

Click on the Article No. for the online configuration in the PIA Life Cycle Portal.

Diameter

DN 10 (3/8")

1 R

DN 15 (1/2")

1 V

DN 25 (1")

2 D

DN 40 (1 1/2")

2 R

DN 50 (2")

2 Y

DN 65 (2 1/2")

3 F

DN 80 (3")

3 M

DN 100 (4")

3 T

Process connections

None (not suitable for 3A approval)

A

Weld in

DIN 11850

B

ISO 2037 (SMS 3008)

C

Tri-Weld/BS 4825-1

D

Clamp type

DIN 32676

G

ISO 2852 (SMS 3016)

H

Tri-Clamp/BS 4825-3

J

Threaded type

DIN 11851

M

SMS 1145¹⁾

N

Liner material

PFA

1

Ceramic

2

Gasket material¹⁾

EPDM flat gasket (3A)

0

FPM/FKM (3A) (only with ceramic liner)

2

EPDM-P gasket (only for PFA) (EHEDG, 3A)

3

Electrode material

Hastelloy C (only with PFA liner)

1

Platinum (only with ceramic liner)

2

Transmitter

Standard sensor for remote transmitter (order transmitter separately), 3A approved

A

Ex sensor for remote transmitter (order transmitter separately) 3A approved

B

MAG 6000 I, Alu.18 ... 90 V DC, 115 ... 230 V AC

C

MAG 6000 I, Aluminum 18 ... 30 V DC, Ex

D

MAG 6000 I, Aluminum 115 ... 230 V AC, Ex

E

MAG 6000, Polyamide, 11 ... 30 V DC/11 ... 24 V AC

H

MAG 6000, Polyamide, 115 ... 230 V AC

J

MAG 5000, Polyamide, 11 ... 30 V DC/11 ... 24 V AC

K

MAG 5000, Polyamide, 115 ... 230 V AC

L

Communication

No communication, add-on possible

A

HART

B

PROFIBUS PA Profile 3

F

(only MAG 6000/MAG 6000 I)

PROFIBUS DP Profile 3 (not for Ex)

G

(only MAG 6000/MAG 6000 I)

Modbus RTU/RS 485 (not for Ex)

E

(only MAG 6000/MAG 6000 I)

FOUNDATION Fieldbus H1

J

(only MAG 6000/MAG 6000 I)

¹⁾ SMS 1145 standard is not approved by 3A

Selection and Ordering data	Article No.
Sensor SITRANS F M MAG 1100 F	7ME6140-
	
Cable glands/terminal box	
Metric: Polyamide terminal box or MAG 6000 I compact	1
½" NPT: Polyamide terminal box or MAG 6000 I compact	2
Metric: Stainless steel terminal box	3
½" NPT: Stainless steel terminal box	4

Selection and Ordering data	Order code
Additional information	
Please add "-Z" to Article No. and specify Order code(s) and plain text.	
Certificates	
Pressure test certificate according to EN 10204-3.1	C01
Material certificate according to EN 10204-3.1	C12
Factory certificate according to EN 10204-2.2	C14
Factory certificate according to EN 10204-2.1	C15
Terminal blocks	
• Factory mounted terminal blocks	N02
Region/customer specific labels	
• KCC label (South Korea)	W28
Tag name plate, stainless steel (specify in plain text)	Y17
Tag name plate, plastic (self adhesive)	Y18
Customer-specific transmitter setting	Y20
Sensor cables wired (specify Article No. for sensor cables and order cables separately)	Y40
Sensor cables wired and IP68 sealing (specify Article No. for sensor cables and order cables separately)	Y41
Special version (specify in plain text)	Y99
Additional calibrations	
• Matched pair - (Standard production calibration where sensor and transmitter is calibrated together)	On request¹⁾
• Accredited Siemens Flow Instruments matched pair Calibration acc. to ISO/IEC 17025: 2005	On request¹⁾
• Customer-specified calibration up to 10 points	On request¹⁾
• Customer-witnessed calibration Any of above calibration	On request¹⁾

¹⁾ Product Variation Request (PVR)

Operating instructions for SITRANS F M MAG 1100F

Description	Article No.
• English	A5E02435647

All literature is available to download for free, in a range of languages, at www.siemens.com/processinstrumentation/documentation

Please use online Product selector to get latest updates.
Product selector link:
www.pia-portal.automation.siemens.com

Accessories

Description	Article No.
Potting kit for IP68/ NEMA 6P sealing of sensor junction box	FDK:085U0220



Flow Measurement

SITRANS F M

Flow sensor MAG 1100 F

Accessories for MAG 1100 F sensor

Article No.

Weld-in connection fittings for use with P gaskets (Stainless steel)

Material: AISI 316L (1.4404)

Only for liner PFA

2 pcs. fittings

2 pcs. clamps (to join flow sensor and fitting),

P gaskets not included

DIN 11850¹⁾

Adapter			Sensor
DN (mm)	D _o (mm)	D _T (mm)	DN (mm)

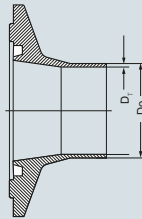

10 ²⁾	13	1.5	10	A5E02054630
15 ²⁾	19	1.5	15	A5E02054633
20	23	1.5	15	A5E02054634
25	29	1.5	25	A5E02054635
32	35	1.5	25	A5E02054637
40	41	1.5	40	A5E02054638
50	53	1.5	50	A5E02054640
65	70	2.0	65	A5E02054643
80	85	2.0	80	A5E02054644
100	104	2.0	100	A5E02054646

ISO 2037¹⁾

Adapter			Sensor
DN (mm)	D _o (mm)	D _T (mm)	DN (mm)

12.7	12.7	1.0	10	A5E03727946
17.2	17.2	1.0	15	A5E03728098
25	25	1.6	25	A5E02196073
33	33.7	1.6	25	A5E02196074
38	38	1.6	40	A5E02196075
40	40	1.6	40	A5E02196076
51	51	1.6	50	A5E02196077
63.5	63.5	1.6	65	A5E02196078
76.1	76.1	1.6	80	A5E02196080
101.6	101.6	2.0	100	A5E02196082

Tri-Weld (BS 4825-1)¹⁾

Adapter			Sensor
DN (mm)	D _o (mm)	D _T (mm)	DN (mm)

12.7	12.7	1.2	10	A5E02199113
19.05	19.05	1.2	15	A5E02199114
25.4	25.4	1.6	25	A5E02199115
38.1	38.1	1.6	40	A5E02199116
50.8	50.8	1.6	50	A5E02199117
63.5	63.5	1.6	65	A5E02199118
76.2	76.2	1.6	80	A5E02199119
101.6	101.6	2.0	100	A5E02199120

Accessories for MAG 1100 F sensor

Article No.

Clamp-type connection fittings for use with P gaskets (Stainless steel)

Material: AISI 316L (1.4404)

Only for liner PFA

2 pcs. fittings

2 pcs. clamps (to join flow sensor and fitting),

P gaskets not included

DIN 32676¹⁾

Adapter			Sensor
DN (mm)	D _o (mm)	D _i (mm)	DN (mm)

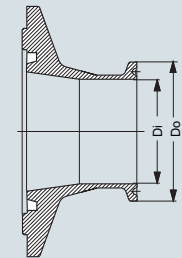

10	34	10	10	A5E02211143
15	34	16	15	A5E02211144
25	50.5	22.6	25	A5E02211146
40	50.5	38	40	A5E02211147
50	64	50	50	A5E02211148
65	91	66	65	A5E02211151
80	106	81	80	A5E02211152
100	119	100	100	A5E02211153

ISO 2852¹⁾

Adapter			Sensor
DN (mm)	D _o (mm)	D _i (mm)	DN (mm)

25	50.5	22.6	25	A5E02213581
33.7	50.5	31.3	25	A5E02213582
38	50.5	35.6	40	A5E02213583
51	64	48.6	50	A5E02213584
63.5	77.5	60.3	65	A5E02213585
76.1	91	72.9	80	A5E02213586
101.6	119	97.6	100	A5E02213587

Tri-Clamp (BS 4825-3)¹⁾

Adapter			Sensor
DN (mm)	D _o (mm)	D _i (mm)	DN (mm)

12.7	25.4	9.5	10	A5E02213596
19.05	25.4	15.85	15	A5E02213597
25.4	50.5	22.2	25	A5E02213598
38.1	50.5	34.9	40	A5E02213599
50.8	64	47.6	50	A5E02213600
63.5	77.5	60.3	65	A5E02213601
76.2	91	73	80	A5E02213602
101.6	119	97.6	100	A5E02213603

D_o: Outer diameterD_i: Inner diameter¹⁾ Suitable for EHEDG²⁾ Not suitable for EHEDG

Accessories for MAG 1100 F sensor Article No.**Threaded type connection fittings for use with P gaskets (Stainless steel)**

Material: AISI 316L (1.4404)

Only for liner PFA

2 pcs. fittings

2 pcs. clamps (to join flow sensor and fitting),

P gaskets not included

DIN 11851¹⁾

Adapter		Sensor	
DN (mm)	D _o (mm)	D _i (mm)	DN (mm)

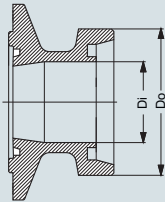

10	28	10	10	A5E02218293
15	34	16	15	A5E02218294
20	44	20	15	A5E02218295
25	52	26	25	A5E02218296
32	58	32	25	A5E02218297
40	65	38	40	A5E02218298
50	78	50	50	A5E02218299
65	95	66	65	A5E02218300
80	110	81	80	A5E02218301
100	130	100	100	A5E02218302

Accessories for MAG 1100 F sensor Article No.**Threaded type connection fittings for use with P gaskets (Stainless steel)**

Material: AISI 316L (1.4404)

Only for liner PFA

2 pcs. fittings

2 pcs. clamps (to join flow sensor and fitting),

P gaskets not included

SMS 1145¹⁾

Adapter		Sensor	
DN (mm)	D _o (mm)	D _i (mm)	DN (mm)

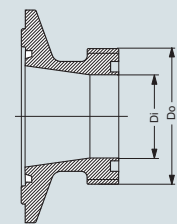

25	40	22.6	25	A5E02218310
38	60	35.6	40	A5E02218312
51	70	48.6	50	A5E02218313
63.5	85	60.3	65	A5E02218314
76	98	72	65	A5E02218315

D_o: Outer diameterD_i: Inner diameter¹⁾ Suitable for EHEDG

Flow Measurement

SITRANS F M

Flow sensor MAG 1100 F

Accessories for MAG 1100 F sensor Article No.

Weld-in connection fittings for use with flat gaskets (Stainless steel)

Material: AISI 316L (1.4404)
For liner PFA and ceramic
2 pcs. fittings
2 pcs. clamps (to join flow sensor and fitting),
Flat gaskets not included

DIN 11850¹⁾

Adapter			Sensor
DN (mm)	D _o (mm)	D _T (mm)	DN (mm)

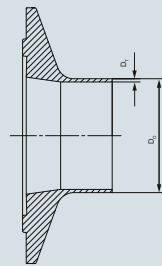

10	13	1.5	10	FDK:083G2116
15	19	1.5	15	FDK:083G2117
20	23	1.5	15	FDK:083G2118
25	29	1.5	25	FDK:083G2119
32	35	1.5	25	FDK:083G2120
40	41	1.5	40	FDK:083G2121
50	53	1.5	50	FDK:083G2122
65	70	2.0	65	FDK:083G2123
80	85	2.0	80	FDK:083G2124
100	104	2.0	100	FDK:083G2125

ISO 2037¹⁾

Adapter			Sensor
DN (mm)	D _o (mm)	D _T (mm)	DN (mm)

12.7	12.7	1.0	10	A5E03720273
17.2	17.2	1.0	15	FDK:083G2107
25	25.6	1.6	25	FDK:083G2109
33.7	33.7	1.6	25	FDK:083G2100
38	38	1.6	40	FDK:083G2111
40	40	1.6	40	FDK:083G2101
51	51	1.6	50	FDK:083G2112
63.5	63.5	1.6	65	FDK:083G2113
76.1	71.1	1.6	80	FDK:083G2114
101.6	101.6	2.0	100	FDK:083G2115
114.3	118.3	2.0	100	FDK:083G2105

Tri-Weld (BS 4825-1)¹⁾

Adapter			Sensor
DN (mm)	D _o (mm)	D _T (mm)	DN (mm)

12.7	12.7	1.2	10	FDK:083G2276
19.05	19.05	1.2	15	FDK:083G2277
25.4	25.4	1.6	25	FDK:083G2279
38	38.1	1.6	40	FDK:083G2281
50.8	50.8	1.6	50	FDK:083G2282
63.5	63.5	1.6	65	FDK:083G2283
76.2	76.2	1.6	80	FDK:083G2284
101.6	101.6	2.0	100	FDK:083G2285

Accessories for MAG 1100 F sensor Article No.

Clamp-type connection fittings for use with flat gaskets (Stainless steel)

Material: AISI 316L (1.4404)
For liner PFA and ceramic
2 pcs. fittings
2 pcs. clamps (to join flow sensor and fitting),
Flat gaskets not included

DIN 32676¹⁾

Adapter			Sensor
DN (mm)	D _o (mm)	D _T (mm)	DN (mm)

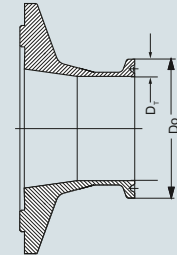

10	34	10	10	FDK:083G2186
15	34	16	15	FDK:083G2187
25	50.5	26	25	FDK:083G2179
40	50.5	38	40	FDK:083G2181
50	64	50	50	FDK:083G2182
65	91	66	65	FDK:083G2183
80	106	81	80	FDK:083G2184
100	119	100	100	FDK:083G2185

ISO 2852¹⁾

Adapter			Sensor
DN (mm)	D _o (mm)	D _T (mm)	DN (mm)

25	50.5	22.6	25	FDK:083G2189
33.7	50.5	31.3	25	FDK:083G2190
38	50.5	35.6	40	FDK:083G2191
51	64	48.6	50	FDK:083G2192
63.5	77.5	60.3	65	FDK:083G2193
76.1	91	72.9	80	FDK:083G2194
101.6	119	97.6	100	FDK:083G2195

Tri-Clamp (BS 4825-3)¹⁾

Adapter			Sensor
DN (mm)	D _o (mm)	D _T (mm)	DN (mm)

12.7	25.4	9.5	10	FDK:083G2286
19.05	25.4	15.85	15	FDK:083G2287
25.4	50.5	22.2	25	FDK:083G2289
38.1	50.5	34.9	40	FDK:083G2291
50.8	64	47.6	50	FDK:083G2292
63.5	77.5	60.3	65	FDK:083G2293
76.2	91	73	80	FDK:083G2294
101.6	119	97.6	100	FDK:083G2295

D_o: Outer diameter

D_i: Inner diameter

¹⁾ Suitable for 3A

Accessories for MAG 1100 F sensor Article No.

Threaded type connection fittings for use with flat gaskets (Stainless steel)

Material: AISI 316L (1.4404)
 For liner PFA and ceramic
 2 pcs. fittings
 2 pcs. clamps (to join flow sensor and fitting),
 Flat gaskets not included

DIN 11851¹⁾

Adapter			Sensor
DN (mm)	D _o (mm)	D _i (mm)	DN (mm)

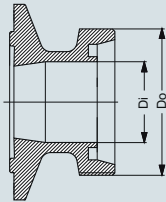

10	28	10	10	FDK:083G2156
15	34	16	15	FDK:083G2157
20	44	20	15	FDK:083G2158
25	52	26	25	FDK:083G2159
32	58	32	25	FDK:083G2160
40	65	38	40	FDK:083G2161
50	78	50	50	FDK:083G2162
65	95	66	65	FDK:083G2163
80	110	81	80	FDK:083G2164
100	130	100	100	FDK:083G2165

ISO 2853¹⁾

Adapter			Sensor
DN (mm)	D _o (mm)	D _i (mm)	DN (mm)

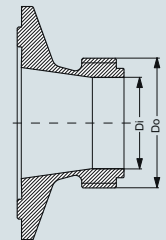

25	37	22.6	25	FDK:083G2149
38	51	35.6	40	FDK:083G2151
51	64	48.6	50	FDK:083G2152
63.5	78	60.3	65	FDK:083G2153
76.1	91	72.9	80	FDK:083G2154

BS 4825-4¹⁾

Adapter			Sensor
DN (mm)	D _o (mm)	D _i (mm)	DN (mm)

101.6	126	97.6	100	FDK:083G2145
-------	-----	------	-----	---------------------

Accessories for MAG 1100 F sensor Article No.

Threaded type connection fittings for use with flat gaskets (Stainless steel)

Material: AISI 316L (1.4404)
 For liner PFA and ceramic
 2 pcs. fittings
 2 pcs. clamps (to join flow sensor and fitting),
 Flat gaskets not included

SMS 1145²⁾

Adapter			Sensor
DN (mm)	D _o (mm)	D _i (mm)	DN (mm)

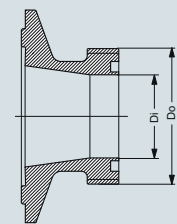

25	40	22.6	25	FDK:083G2139
38	60	35.6	40	FDK:083G2141
51	70	48.6	50	FDK:083G2142
63.5	85	60.3	65	FDK:083G2143
76	98	72	65	FDK:083G2144

D_o: Outer diameter

D_i: Inner diameter

¹⁾ Suitable for 3A

²⁾ Not suitable for 3A

Flow Measurement

SITRANS F M

Flow sensor MAG 1100 F

Spare parts for MAG 1100 F sensor

Article No.

Gaskets

(delivered in pairs, to be placed between flow sensor and adapter)

MAG 1100 F (PFA) - P gaskets

Rubber: EPDM

- | | |
|----------|--------------------|
| • DN 10 | A5E02055286 |
| • DN 15 | A5E02055287 |
| • DN 25 | A5E02055290 |
| • DN 40 | A5E02055291 |
| • DN 50 | A5E02055292 |
| • DN 65 | A5E02055293 |
| • DN 80 | A5E02055295 |
| • DN 100 | A5E02055297 |

MAG 1100 F (ceramic) - Flat gaskets

Rubber: FKM/FPM

- | | |
|----------|--------------------|
| • DN 10 | A5E00915707 |
| • DN 15 | A5E00915764 |
| • DN 25 | A5E00915771 |
| • DN 40 | A5E00915773 |
| • DN 50 | A5E00915775 |
| • DN 65 | A5E00915780 |
| • DN 80 | A5E00915782 |
| • DN 100 | A5E00915784 |

MAG 1100 F (PFA, ceramic) - Flat gaskets

Rubber: EPDM

- | | |
|----------|---------------------|
| • DN 10 | FDK:083G2206 |
| • DN 15 | FDK:083G2207 |
| • DN 25 | FDK:083G2209 |
| • DN 40 | FDK:083G2211 |
| • DN 50 | FDK:083G2212 |
| • DN 65 | FDK:083G2213 |
| • DN 80 | FDK:083G2214 |
| • DN 100 | FDK:083G2215 |

Rubber: NBR

- | | |
|----------|---------------------|
| • DN 10 | FDK:083G2216 |
| • DN 15 | FDK:083G2217 |
| • DN 25 | FDK:083G2219 |
| • DN 40 | FDK:083G2221 |
| • DN 50 | FDK:083G2222 |
| • DN 65 | FDK:083G2223 |
| • DN 80 | FDK:083G2224 |
| • DN 100 | FDK:083G2225 |

Dimensional drawings

Sensor MAG 1100 F compact/remote

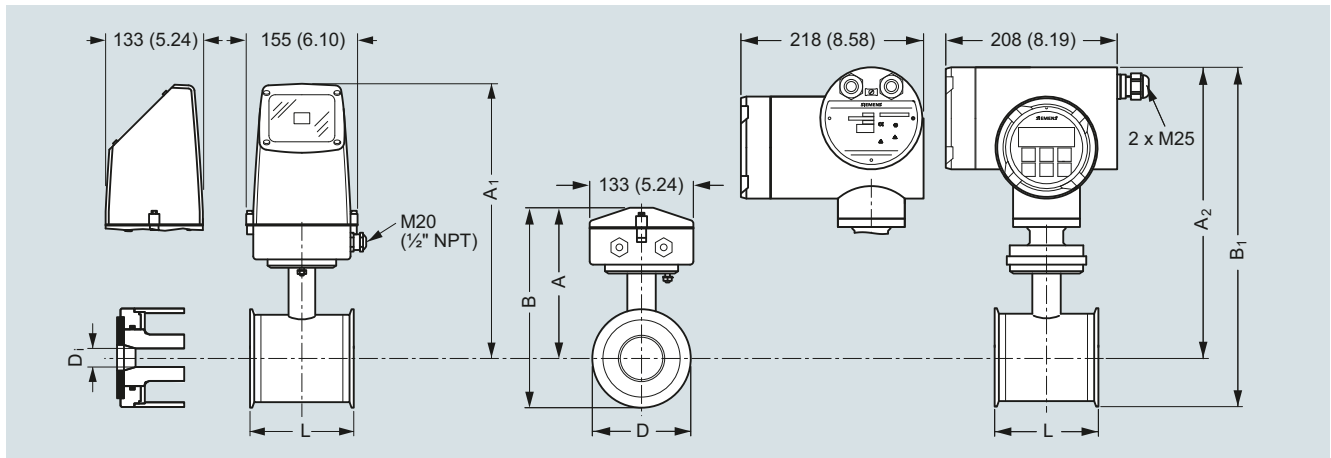

Dimensions in mm (inch)

Important note:**For compact installation with MAG 6000 I/Ex - Supports the transmitter to avoid tension on the sensor part.**

Size	L	A	A ₁ ³⁾	B ²⁾	B ₁	D	D _i (Al ₂ O ₃) [mm]	D _i PFA [mm]	Weight ¹⁾
DN	[mm]	[mm]	[mm]	[mm]	[mm]	[mm]	[mm]	[mm]	[kg]
10	64	161	315	193.7	344.7	64.0	10	10	2.2
15	64	161	315	193.7	344.7	64.0	15	16	2.2
25	79	169	323	207.5	359.0	77.5	25	26	2.7
40	94	179	333	228.0	379.0	91.0	40	38	3.4
50	104	188	342	247.7	398.7	119.0	50	50	4.2
65	131	197.5	351	262.6	413.6	130.0	65	66	5.5
80	156	204	357	281.0	432.0	155.0	80	81	7.0
100	186	217	370	308.0	459.0	183.0	100	100	10.0

Size	L	A	A ₁ ³⁾	B ²⁾	B ₁	D	D _i (Al ₂ O ₃) [inch]	D _i PFA [inch]	Weight ¹⁾
[inch]	[inch]	[inch]	[inch]	[inch]	[inch]	[inch]	[inch]	[inch]	[lb]
3/8	2.52	6.34	12.40	7.62	13.57	2.52	0.39	0.39	4.8
1/2	2.52	6.34	12.40	7.62	13.57	2.52	0.59	0.63	4.8
1	3.11	6.66	12.72	8.17	14.13	3.05	0.98	1.02	4.9
1 1/2	3.70	7.05	13.11	8.98	14.92	3.58	1.57	1.50	7.5
2	4.09	7.40	13.47	9.75	15.70	4.68	1.97	1.97	9.2
2 1/2	5.16	7.78	13.82	10.34	16.28	5.12	2.56	2.60	12.0
3	6.14	8.03	14.06	11.06	17.01	6.10	3.15	3.19	15.0
4	7.32	8.54	14.57	12.13	18.07	7.20	3.94	3.94	22.0

¹⁾ With transmitter MAG 5000 or MAG 6000 compact, weight is increased by approximately 0.8 kg (1.8 lb)
With MAG 6000 I weight is increased with 5.5 kg (12.1 lb)

²⁾ 14.5 mm (0.571") shorter when the stainless steel terminal box is used (always Ex version)

³⁾ A₂ is 3 mm (0.12") shorter than A₁

Flow Measurement

SITRANS F M

Flow sensor MAG 1100 F

Sensor MAG 1100 F compact/separate – built-in length

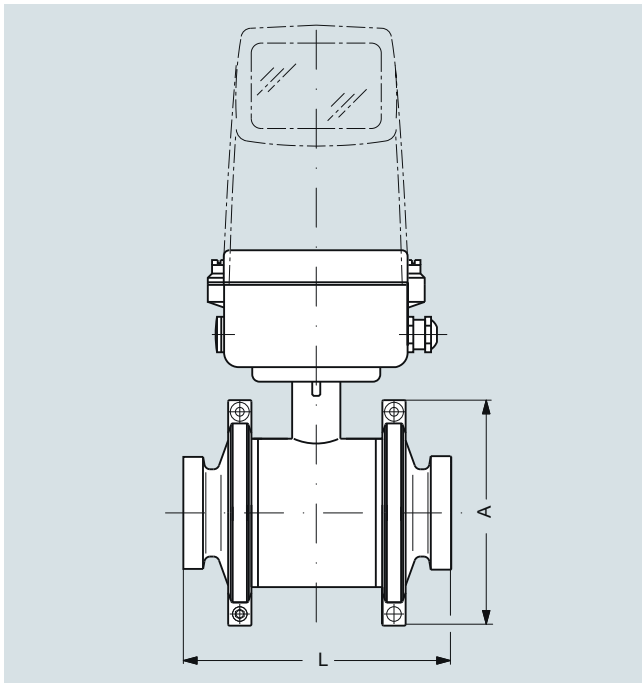

Size		A		L ¹⁾	
DN	inch	[mm]	[inch]	[mm]	[inch]
10	3/8	99	3.90	146	5.75
15	1/2	99	3.90	146	5.75
25	1	113	4.45	161	6.34
40	1 1/2	126	4.96	176	6.93
50	2	154	6.06	186	7.32
65	2 1/2	165	6.50	223	8.78
80	3	200	7.87	258	10.16
100	4	225	8.86	288	11.34

¹⁾ The total built-in length "L" is independent of the adapter type selected.