

Flow Measurement

SITRANS F M

Flow sensor MAG 1100 and MAG 1100 HT

Overview



The SITRANS F M MAG 1100 is an electromagnetic flow sensor in a compact wafer design designed for flow applications in the process industry.

Benefits

- Sensor sizes: DN 2 to 100 (1/12" to 4")
- Compact wafer design meets EN 1092, DIN and ANSI flange standards
- Corrosion resistant AISI 316 stainless steel sensor housing
- Highly resistant liner and electrodes fitting most extreme process media
- Temperature rating up to 200 °C (392 °F)
- Hose proof IP67/NEMA 4X enclosure rating
- Designed that patented in-situ verification can be conducted. Using SENSORPROM fingerprints.

Application

The main applications of the SITRANS F M electromagnetic flow sensors can be found in the following fields:

- Process industry
- Chemical industry
- Pharmaceutical industry
- Water treatment like e.g. chemical dosing

Design

- Compact or remote mounting possible
- Easy "plug & play" field changeability of transmitter
- Simple on site upgrade to IP68/NEMA 6P terminal box
- ATEX 2G D version
- FM Class I, Div 2

Mode of operation

The flow measuring principle is based on Faraday's law of electromagnetic induction according to which the sensor converts the flow into an electrical voltage proportional to the velocity of the flow.

Integration

The complete flowmeter consists of a flow sensor and an associated transmitter SITRANS F M MAG 5000, 6000 or 6000 I. The flexible communication concept USM II simplifies integration and update to a variety of fieldbus systems such as HART, FOUNDATION Fieldbus H1, DeviceNet, PROFIBUS DP and PA, Modbus RTU/RS 485.

Technical specifications

Version	MAG 1100	MAG 1100 HT (High temperature)
Measuring principle	Electromagnetic induction	Electromagnetic induction
Excitation frequency (Mains supply: 50 Hz/60 Hz)	DN 2 ... 65 (1/12" ... 2 1/2"): 12.5 Hz/15 Hz DN 80, 100 (3", 4"): 6.25 Hz/7.5 Hz	DN 15 ... 50 (1/2" ... 2"): 12.5 Hz/15 Hz DN 80, 100 (3", 4"): 6.25 Hz/7.5 Hz
Process connection		
Nominal size		
• MAG 1100 (Ceramic)	DN 2 ... DN 100 (1/12" ... 4")	DN 15 ... DN 100 (1/2" ... 4")
• MAG 1100 (PFA)	DN 10 ... DN 100 (3/8" ... 4")	
Mating flanges	EN 1092-1 (DIN 2501), ANSI B 16.5 class 150 and 300 or equivalent Option: DN 2 ... 10 (1/12" ... 3/8"): G 1/2" / NPT 1/2" pipe connection adapters	EN 1092-1 (DIN 2501), ANSI B 16.5 class 150 and 300 or equivalent
Rated operating conditions		
<u>Ambient conditions</u>		
Ambient temperature		
• Standard sensor	-40 ... +100 °C (-40 ... +212 °F)	-40 ... +100 °C (-40 ... +212 °F)
• Ex sensor	-20 ... +60 °C (-4 ... +140 °F)	-20 ... +60 °C (-4 ... +140 °F)
• Compact with transmitter MAG 5000/6000	-20 ... +60 °C (-4 ... +140 °F)	
• Compact with transmitter MAG 6000 I	-20 ... +60 °C (-4 ... +140 °F)	
• Compact with transmitter MAG 6000 I Ex	-20 ... +60 °C (-4 ... 140 °F)	
<u>Temperature of medium</u>		
• MAG 1100 (Ceramic)	-20 ... +150 °C (-4 ... +302 °F)	-20 ... +200 °C (-4 ... +392 °F)
• MAG 1100 Ex (Ceramic)	-20 ... +150 °C (-4 ... +302 °F)	-20 ... +180 °C (-4 ... +356 °F)
• MAG 1100 (PFA)	-30 ... +130 °C (-22 ... +266 °F) Suitable for steam sterilization at 150 °C (302 °F)	
<u>Temperature shock</u>		
• MAG 1100 (Ceramic)		
- Duration ≤ 1 min, followed by 10 min rest	<ul style="list-style-type: none"> • DN 2, 3 (1/12", 1/8") No limitations • DN 6, 10, 15, 25: Max. ΔT ≤ 80 °C/min (1/4", 3/8", 1/2", 1": Max. ΔT ≤ 144 °F/min) • DN 40, 50, 65: Max. ΔT ≤ 70 °C/min (1 1/2", 2", 2 1/2": Max. ΔT ≤ 126 °F/min) • DN 80, 100: Max. ΔT ≤ 60 °C/min (3", 4": Max. ΔT ≤ 108 °F/min) 	<ul style="list-style-type: none"> • DN 15, 25: Max. ΔT ≤ 80 °C/min (1/2", 1": Max. ΔT ≤ 144 °F/min) • DN 40, 50: Max. ΔT ≤ 70 °C/min (1 1/2", 2": Max. ΔT ≤ 126 °F/min) • DN 80, 100: Max. ΔT ≤ 60 °C/min (3", 4": Max. ΔT ≤ 108 °F/min)
• MAG 1100 (PFA)	Max. ± 100 °C (212 °F) momentarily	
<u>Operating pressure</u>		
• MAG 1100 (Ceramic)	<ul style="list-style-type: none"> • DN 2 ... 65: 40 bar (1/12" ... 2 1/2": 580 psi) • DN 80: 37.5 bar (3": 540 psi) • DN 100: 30 bar (4": 435 psi) Vacuum: 1×10^{-6} bar _{abs} (1.5×10^{-5} psi _{abs})	<ul style="list-style-type: none"> • DN 15 ... 50: 40 bar (1/2" ... 2": 580 psi) • DN 80: 37.5 bar (3": 540 psi) • DN 100: 30 bar (4": 435 psi) Vacuum: 1×10^{-6} bar _{abs} (1.5×10^{-5} psi _{abs})
• MAG 1100 (PFA)	20 bar (290 psi) Vacuum: 0.02 bar _{abs} (0.3 psi _{abs}) DN 80 ... DN 100: CO ₂ pressure max. 7 bar (101.5 psi)	
<u>Mechanical load (vibration)</u>		
	<ul style="list-style-type: none"> • 18 ... 1000 Hz random in x, y, z, directions for 2 hours according to EN 60068-2-36 • Sensor: 3.17 g RMS • Sensor with compact MAG 5000/ 6000 mounted transmitter: 3.17 g RMS • Sensor with compact MAG 6000 I/ 6000 I Ex mounted transmitter: 1.14 g RMS • For compact installation with the MAG 6000 I, transmitter to be supported to avoid tension on sensor part. 	<ul style="list-style-type: none"> • 18 ... 1000 Hz random in x, y, z, directions for 2 hours according to EN 60068-2-36 • Sensor: 3.17 g RMS
<u>Enclosure rating (standard)</u>	IP67 to EN 60529 (NEMA 4X), 1 mH ₂ O for 30 min	IP67 to EN 60529 (NEMA 4X), 1 mH ₂ O for 30 min
EMC	2014/30/EU	2014/30/EU

Flow Measurement

SITRANS F M

Flow sensor MAG 1100 and MAG 1100 HT

Version	MAG 1100	MAG 1100 HT (High temperature)
Design		
Weight	See Dimensional drawings	See Dimensional drawings
Material		
• Enclosure		
- MAG 1100	Stainless steel AISI 316L/1.4404	Stainless steel AISI 316L/1.4404
• Terminal box		
- Standard	Fibre glass reinforced polyamide (not for Ex)	Stainless steel AISI 316/1.4436
- Option	Stainless steel AISI 316/1.4436	
• Fixing studs		
	Stainless steel AISI 304/1.4301, Number and size to EN 1092-1:2001	Stainless steel AISI 304/1.4301, Number and size to EN 1092-1:2001
• Gaskets		
- Standard	EPDM (max. 150 °C, PN 40 (max. 302 °F, 600 psi))	Graphite (max. 200 °C, PN 40 (max. 392 °F, 600 psi))
- Option	• Graphite (max. 200 °C, PN 40 (max. 392 °F, 600 psi)) • PTFE (max. 130 °C, PN 25 (max. 266 °F, 300 psi))	
• Pipe connection adapters: DN 2, 3, 6 and 10 (1/12", 1/8", 1/4" and 3/8")	• Stainless steel, AISI 316/1.4436 • Hastelloy C22/2.4602 • PVDF	
Liner		
• MAG 1100 (Ceramic)	• DN 2, 3 (1/12", 1/8"): Zirconium oxide (ZrO ₂) (ceramic) • DN 6 ... 100 (1/4" ... 4"): Aluminum oxide Al ₂ O ₃	DN 15 ... 100 (1/2" ... 4"): Aluminum oxide Al ₂ O ₃
• MAG 1100 (PFA)	Reinforced PFA (not for Ex)	
Electrodes		
• MAG 1100 (Ceramic)	• DN10 ... 100 (3/8" ... 4") : Platinum with gold / Titanium brazing alloy • DN 2 ... 6 (1/12" ... 1/4"): Platinum	Platinum with gold / Titanium brazing alloy
• MAG 1100 (PFA)	• DN 10 ... 15 (3/8" ... 1/2"): Hastelloy C276/2.4819 • DN 25 ... 100 (1" ... 4"): Hastelloy C22/2.4602	
Cable entries		
	• Remote installation 2 x M20 or 2 x 1/2" NPT • Compact installation - MAG 5000/MAG 6000: 4 x M20 or 4 x 1/2" NPT - MAG 6000 I: 2 x M25 (for supply/output) - MAG 6000 I Ex: 2 x M25 (for supply/output)	Remote installation 2 x M20 or 2 x 1/2" NPT
Certificates and approvals		
Calibration		
• Standard production calibration	Zero-point, 2 x 25 %, 2 x 90 %	Zero-point, 2 x 25 %, 2 x 90 %
• Special calibration	5-point calibration: 20 %, 40 %, 60 %, 80 %, 100 % of factory Q _{max} 10-point calibration: ascending and descending at 20 %, 40 %, 60 %, 80 %, 100 % of factory Q _{max} Matched-pair calibration: default, 5-point or 10-point	
Hazardous areas		
• MAG 1100 F (Ceramic)		
- Ex sensor in compact or remote version with MAG 6000 I Ex	ATEX, EAC Ex - Zone 1 Ex d e ia IIB T6 Gb	ATEX, EAC Ex - Zone 1 Ex d e ia IIB T6 Gb
- Standard sensor in compact or remote version with MAG 5000/6000/6000 I	ATEX - Zone 21 Ex tD A21 IP67	ATEX - Zone 21 Ex tD A21 IP67
• MAG 1100 F (PFA)		
- Standard sensor in compact or remote version with MAG 5000/6000/6000 I	FM - NI Class I Div. 2 Groups A, B, C, D	FM - NI Class I Div. 2 Groups A, B, C, D
Hygienic		
• MAG 1100 F (Ceramic)	3A (remote version with Polyamide terminal box)	
• MAG 1100 F (PFA)	3A (remote version with Polyamide terminal box) EHEDG (remote version with Polyamide terminal box, DN 25 ... 100/1 ... 4") Hygienic EC 1935:2004 European food contact material	
Pressure Equipment	PED - 2014/68/EU CRN (only PFA)	PED - 2014/68/EU
Others	EAC (Russia, Belarus, Kazakhstan) KCC (South Korea)	EAC (Russia, Belarus, Kazakhstan) KCC (South Korea)

For technical specification for transmitter - see transmitter pages.

Selection and Ordering data	Article No.	Selection and Ordering data	Order code
Sensor SITRANS F M MAG 1100 EPDM gaskets included ↗ Click on the Article No. for the online configuration in the PIA Life Cycle Portal.	↗ 7ME6110- A 0 -	Additional information Please add "-Z" to Article No. and specify Order code(s) and plain text. Certificates	
Diameter DN 2 (1/12") DN 3 (1/8") DN 6 (1/4") DN 10 (3/8") DN 15 (1/2") DN 25 (1") DN 40 (1 1/2") DN 50 (2") DN 65 (2 1/2") DN 80 (3") DN 100 (4")	1 D 1 H 1 M 1 R 1 V 2 D 2 R 2 Y 3 F 3 M 3 T	<ul style="list-style-type: none"> Material certificate according to EN 10204-3.1 Factory certificate according to EN 10204-2.2 Factory certificate according to EN 10204-2.1 Special calibration <ul style="list-style-type: none"> 5-point calibration¹⁾ 10-point calibration²⁾ <ul style="list-style-type: none"> Default (2 x 25 % and 2 x 90 %) matched-pair calibration 5-point, matched-pair calibration¹⁾ 10-point, matched-pair calibration²⁾ Terminal blocks <ul style="list-style-type: none"> Factory mounted terminal blocks Region/customer specific labels <ul style="list-style-type: none"> KCC label (South Korea) Tag name plate, stainless steel (specify in plain text) Tag name plate, plastic (self adhesive) Customer-specific transmitter setting Sensor cables wired (specify Article No. for sensor cables and order cables separately) Sensor cables wired and IP68 sealing (specify Article No. for sensor cables and order cables separately) Special version (specify in plain text)	C12 C14 C15 D01 D06 D11 D15 D18 N02 W28 Y17 Y18 Y20 Y40 Y41 Y99
Liner material PFA - DN 10 ... 100 (3/8" ... 4") Ceramic	1 2	Additional calibrations <ul style="list-style-type: none"> Accredited Siemens Flow Instruments matched pair Calibration acc. to ISO/IEC 17025: 2005 Customer-specified calibration up to 10 points Customer-witnessed calibration Any of above calibration	On request³⁾ On request³⁾ On request³⁾
Electrode material Hastelloy C (only with PFA liner) Platinum (only with ceramic liner)	1 2	Sensor cables wired (specify Article No. for sensor cables and order cables separately)	Y40
Transmitter Standard sensor for remote transmitter (order transmitter separately) Ex sensor for remote transmitter (order transmitter separately) MAG 6000 I, Aluminum 18 ... 90 V DC, 115 ... 230 V AC MAG 6000 I, Aluminum 18 ... 30 V DC, Ex MAG 6000 I, Aluminum 115 ... 230 V AC, Ex MAG 6000 Polyamide, 11 ... 30 V DC/ 11 ... 24 V AC MAG 6000, Polyamide, 115 ... 230 V AC MAG 5000, Polyamide, 11 ... 30 V DC/ 11 ... 24 V AC MAG 5000, Polyamide, 115 ... 230 V AC	A B C D E H J K L	Additional calibrations	On request³⁾
Communication No communication, add-on possible HART PROFIBUS PA Profile 3 (only MAG 6000/MAG 6000 I) PROFIBUS DP Profile 3 (not for Ex) (only MAG 6000/MAG 6000 I) Modbus RTU/RS 485 (not for Ex) (only MAG 6000/MAG 6000 I) FOUNDATION Fieldbus H1 (only MAG 6000/MAG 6000 I)	A B F G E J	Additional calibrations	On request³⁾
Cable glands/terminal box Metric: Polyamide terminal box or MAG 6000 I compact 1/2" NPT: Polyamide terminal box or MAG 6000 I compact Metric: Stainless steel terminal box 1/2" NPT: Stainless steel terminal box	1 2 3 4	Additional calibrations	On request³⁾
1) Quick ship only in combination with Ceramic liner		Operating instructions for SITRANS F M MAG 1100 Description Article No. <ul style="list-style-type: none"> English A5E02435647 All literature is available to download for free, in a range of languages, at www.siemens.com/processinstrumentation/documentation	
		Accessories Description Article No. Potting kit for IP68/ NEMA 6P sealing of sensor junction box FDK:085U0220	

Flow Measurement

SITRANS F M

Flow sensor MAG 1100 and MAG 1100 HT

Selection and Ordering data	Article No.
Sensor SITRANS F M	
MAG 1100 HT High Temperature	7 ME 6 1 2 0 -
Ceramic liner, Platinum electrode, Graphite gaskets included	A 2 0 - 2 A
↗ Click on the Article No. for the online configuration in the PIA Life Cycle Portal.	
Diameter	
DN 15 (½")	1 V
DN 25 (1")	2 D
DN 40 (1½")	2 R
DN 50 (2")	2 Y
DN 80 (3")	3 M
DN 100 (4")	3 T
Transmitter	
Standard sensor for remote transmitter (order trans- mitter separately)	A
Ex sensor for remote transmitter (order transmitter separately)	B
Cable glands/terminal box	
Metric: Stainless steel terminal box	3
½" NPT: Stainless steel terminal box	4

Selection and Ordering data	Order code
Additional information	
Please add "-Z" to Article No. and specify Order code(s) and plain text.	
Certificates	
• Material certificate according to EN 10204-3.1	C12
• Factory certificate according to EN 10204-2.2	C14
• Factory certificate according to EN 10204-2.1	C15
Special calibration	
• 5-point calibration ¹⁾	D01
• 10-point calibration ²⁾	D06
• Default (2 x 25 % and 2 x 90 %) matched-pair calibration	D11
• 5-point, matched-pair calibration ¹⁾	D15
• 10-point, matched-pair calibration ²⁾	D18
Terminal blocks	
• Factory mounted terminal blocks	N02
Region/customer specific labels	
• KCC label (South Korea)	W28
Tag name plate, stainless steel (specify in plain text)	Y17
Tag name plate, plastic (self adhesive)	Y18
Customer-specific transmitter setting	Y20
Sensor cables wired (specify Article No. for sensor cables and order cables separately)	Y40
Sensor cables wired and IP68 sealing (specify Article No. for sensor cables and order cables separately)	Y41
Special version (specify in plain text)	Y99
Additional calibrations	
• Accredited Siemens Flow Instruments matched pair Calibration acc. to ISO/IEC 17025: 2005	On request³⁾
• Customer-specified calibration up to 10 points	On request³⁾
• Customer-witnessed calibration Any of above calibration	On request³⁾

¹⁾ 20 %, 40 %, 60 %, 80 %, 100 % of factory Q_{max}

²⁾ Ascending and descending at 20 %, 40 %, 60 %, 80 %, 100 % of factory Q_{max}









³⁾ Product Variation Request (PVR)

Operating instructions for SITRANS F M MAG 1100

Description	Article No.
• English	A5E02435647
All literature is available to download for free, in a range of languages, at www.siemens.com/processinstrumentation/documentation	
Please use online Product selector to get latest updates.	
Product selector link: www.pia-portal.automation.siemens.com	

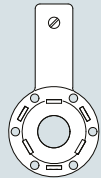
Accessories

Description	Article No.
Potting kit for IP68/NEMA 6P sealing of sensor junction box	FDK:085U0220
	

Accessories for MAG 1100 sensor	Article No.	Accessories for MAG 1100 sensor	Article No.
Pipe connection ½" external thread For DN 2 ... 10 (1/12" ... 3/8") sensor, material: Stainless steel AISI 316L 2 pcs. pipe connections, 2 pcs. EPDM gaskets, 12 pcs. M4x12 screws		Grounding ring (Stainless steel) Material: AISI 316/1.4436; each set includes: 1 pc. grounding ring ¹⁾ , 3 pcs. PTFE gaskets, 1 pc. grounding wire, 1 pc. M6 screw	
<ul style="list-style-type: none"> • ½" G, ISO 7-1 tapered thread, AISI 316L • ½" NPT thread, AISI 316L For DN 2 ... 10 (1/12" ... 3/8") sensor, material: Hastelloy C 2 pcs. pipe connections, 2 pcs. PTFE gaskets, 12 pcs. M4x14 screws	FDK:083G0080 FDK:083G4330	<ul style="list-style-type: none"> • DN 2 ... 10 (1/12" ... 3/8") • DN 15 (½") • DN 25 (1") • DN 40 (1½") • DN 50 (2") • DN 65 (2½") • DN 80 (3") • DN 100 (4") 	FDK:083G0686 FDK:083G0687 FDK:083G0689 FDK:083G0691 FDK:083G0692 FDK:083G0693 FDK:083G0694 FDK:083G0695
<ul style="list-style-type: none"> • ½" G, ISO 7-1 tapered thread • ½" NPT thread For DN 2...10 (1/12"...3/8") sensor 2 pcs. PVDF pipe connections (Max. 70 °C, PN 8 bar/max 158 °F, 116 PSI), 1 pc. grounding ring ¹⁾ , 1 pc. grounding wire, 3 pcs. PTFE gas- kets, 2 pcs. space rings, 6 pcs. M4x12 and 6 pcs. M4x20 screws	FDK:083G4332 FDK:083G4331	Grounding ring (Hastelloy C) Material: Hastelloy C22/2.4602; each set includes: 1 pc. grounding ring ¹⁾ , 3 pcs. PTFE gaskets, 1 pc. grounding wire, 1 pc. M6 screw	
<ul style="list-style-type: none"> • ½"G, ISO 7-1 tapered thread PVDF incl. grounding ring Hastelloy C22/2.4602 • ½" NPT thread PVDF incl. grounding ring Hastelloy C22/2.4602 	A5E01018395 A5E01018400	<ul style="list-style-type: none"> • DN 2 ... 10 (1/12" ... 3/8") • DN 15 (½") • DN 25 (1") • DN 40 (1½") • DN 50 (2") • DN 65 (2½") • DN 80 (3") • DN 100 (4") 	FDK:083G3256 FDK:083G3257 FDK:083G3259 FDK:083G3261 FDK:083G3262 FDK:083G3263 FDK:083G3264 FDK:083G3265
EPDM gaskets Material: EPDM; each set includes: 2 pcs. EPDM gaskets, 1 pc. grounding wire, 1 pc. M6 screw, 1 pc. nut, 1 pc. washer, 1 pc. bolt grounding plate		Grounding ring (Tantalum) Material: Tantalum; each set includes: 1 pc. grounding ring ¹⁾ , 3 pcs. PTFE gaskets, 1 pc. grounding wire, 1 pc. M6 screw	
<ul style="list-style-type: none"> • DN 2 ... 10 (1/12" ... 3/8") • DN 15 (½") • DN 25 (1") • DN 40 (1½") • DN 50 (2") • DN 65 (2½") • DN 80 (3") • DN 100 (4") 	FDK:083G3116 FDK:083G3117 FDK:083G3119 FDK:083G3121 FDK:083G3122 FDK:083G3123 FDK:083G3124 FDK:083G3125	<ul style="list-style-type: none"> • DN 2 ... 10 (1/12" ... 3/8") 	A5E01181599
PTFE gaskets Material: PTFE; each set includes: 2 pcs. gaskets, 2 pcs. grounding wires, 3 pcs. M6 screws (DN 2 ... DN 10: 12 pcs. M4x14)		<ul style="list-style-type: none"> • DN 15 (½") • DN 25 (1") • DN 40 (1½") • DN 50 (2") • DN 65 (2½") • DN 80 (3") • DN 100 (4") 	
<ul style="list-style-type: none"> • DN 2 ... 10 (1/12" ... 3/8") • DN 15 (½") • DN 25 (1") • DN 40 (1½") • DN 50 (2") • DN 65 (2½") • DN 80 (3") • DN 100 (4") 	FDK:083G0156 FDK:083G0157 FDK:083G0159 FDK:083G0161 FDK:083G0162 FDK:083G0163 FDK:083G0164 FDK:083G0165	<ul style="list-style-type: none"> • DN 15 (½") • DN 25 (1") • DN 40 (1½") • DN 50 (2") • DN 65 (2½") • DN 80 (3") • DN 100 (4") 	A5E01181606 A5E01181610 A5E01181613 A5E01181615 A5E01181616 A5E01181619 A5E01181622
Graphite gaskets Material: Graphite; conductive, each set includes: 2 pcs. gaskets (can also be used as grounding ring)		Studs and nuts for DN 100 PN 25/40, 8 pcs. M20 studs, 16 pcs. M20 nuts	
<ul style="list-style-type: none"> • DN 2 ... 10 (1/12" ... 3/8") • DN 15 (½") • DN 25 (1") • DN 40 (1½") • DN 50 (2") • DN 65 (2½") • DN 80 (3") • DN 100 (4") 	FDK:083G0116 FDK:083G0117 FDK:083G0119 FDK:083G0121 FDK:083G0122 FDK:083G0123 FDK:083G0124 FDK:083G0125	Material: AISI 304/1.4305 <ul style="list-style-type: none"> • DN 100 (4") 	FDK:083G0226

¹⁾ Thickness of grounding ring is 2 mm (0.08 inch)

The total built-in length "L" [mm]/[inch] before assembling depends on the gasket selected

Size DN	inch	EPDM		Graphite		PTFE (Teflon)		Without gasket		Grounding ring	
		[mm]	[inch]	[mm]	[inch]	[mm]	[inch]	[mm]	[inch]	[mm]	[inch]
2 ... 10 ¹⁾	1/12 ... 3/8	64	2.52	66	2.60	70	2.75	64	2.52	77	3.03
15	1/2	65	2.56	66	2.60	70	2.75	64	2.52	77	3.03
25	1	80	3.15	81	3.19	85	3.35	79	3.10	92	3.62
40	1 1/2	95	3.74	96	3.78	100	3.94	94	3.70	107	4.21
50	2	105	4.13	106	4.17	110	4.33	104	4.05	117	4.61
65	2 1/2	130	5.12	131	5.15	135	5.31	129	5.05	142	5.60
80	3	155	6.10	156	6.14	160	6.30	154	6.00	167	6.57
100	4	185	7.28	186	7.31	190	7.48	184	7.20	197	7.76

1) Mounting between two flanges

Sensor MAG 1100 DN 2 ... 10 (1/12" ... 3/8") with adapters

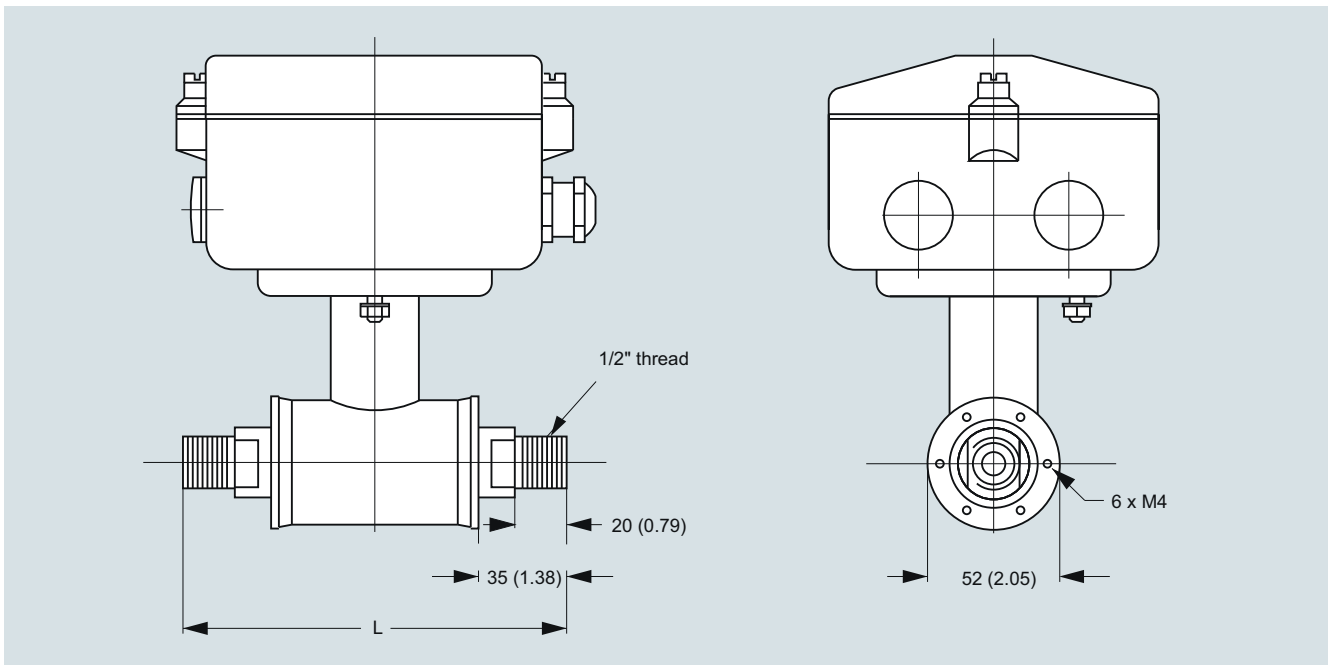

The MAG 1100 DN 2, 3, 6 and 10 (1/12", 1/8", 1/4" and 3/8") are prepared for assembly with the 1/2" pipe connections. Dimensions in mm (inch)

The length "L" varies dependent on the gasket choice.

Stainless steel and Hastelloy pipe connections								PVDF pipe connections	
Without gasket		EPDM		Graphite		PTFE		PTFE	
[mm]	[inch]	[mm]	[inch]	[mm]	[inch]	[mm]	[inch]	[mm]	[inch]
150	5.9	150	5.9	152	6.0	156	6.1	133	5.2

Important note:

For compact installation with the MAG 6000 I, transmitter to be supported to avoid tension on sensor part.