

Overview

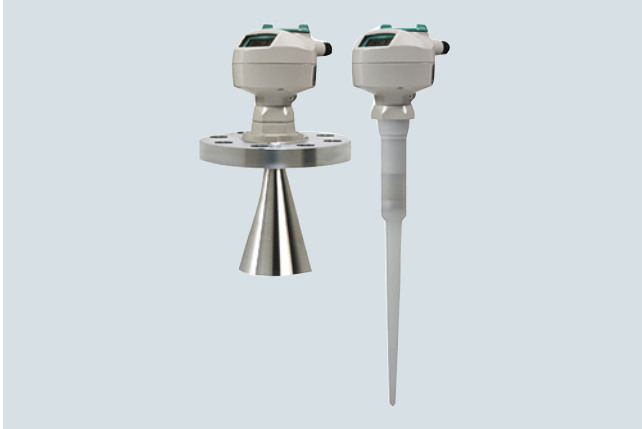

SITRANS LR200 is a 2-wire, 6 GHz pulse radar level transmitter for continuous monitoring of liquids and slurries in process vessels including high temperature, pressure, agitation, and turbulence to a range of 20 m (65 ft).

Benefits

- Graphical local user interface (LUI) makes operation simple with plug-and-play setup using the intuitive Quick Start Wizard
- LUI displays echo profiles for diagnostic support
- Communication using HART or PROFIBUS PA
- Process Intelligence signal processing for improved measurement reliability and Auto False-Echo Suppression of fixed obstructions
- Programming using infrared Intrinsically Safe handheld programmer or SIMATIC PDM

Application

SITRANS LR200's unique design allows safe and simple programming using the Intrinsically Safe handheld programmer without having to open the instrument's lid. It also features a built-in alphanumeric display in four languages.

The SITRANS LR200 has a standard Uni-Construction polypropylene rod antenna that offers excellent chemical resistance and is hermetically sealed. The Uni-Construction antenna features an internal, integrated shield that eliminates vessel nozzle interference.

Startup is easy with as few as two parameters for basic operation. Installation is simplified as the electronics are mounted on a rotating head that swivels, allowing the instrument to line up with conduit or wiring connections or simply to adjust the position for easy viewing. SITRANS LR200 features Process Intelligence signal-processing technology for superior reliability.

- Key Applications: liquid process vessels with agitators, vaporous liquids, high temperatures, asphalt

Configuration

Installation

Min. 300 mm (1 ft) for every 3 m (10 ft) of vessel wall.

Note:

- Beam angle is the width of the cone where the energy density is half of the peak energy density.
- Beam angle for horn antenna dependent on horn size
- The peak energy density is directly in front of and in line with the rod antenna.
- There is a signal transmitted outside of the beam angle; therefore false targets may be detected.

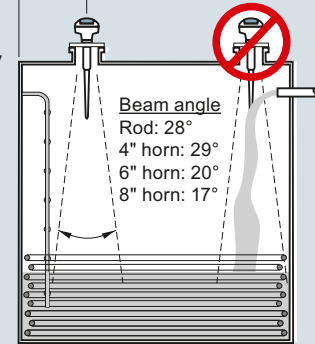

Mounting unit on vessel

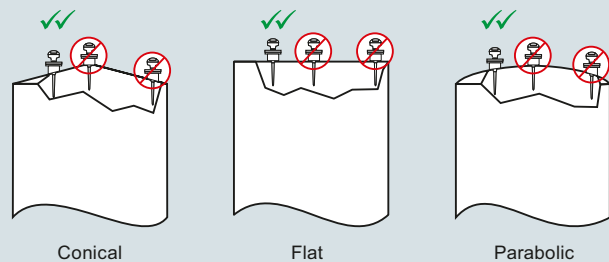

Mounting unit on stilling well

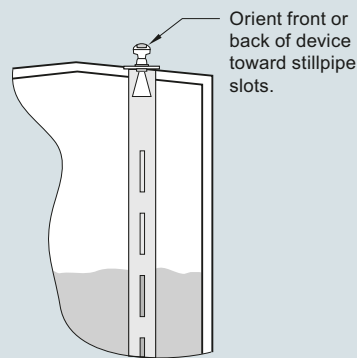

Mounting on a nozzle

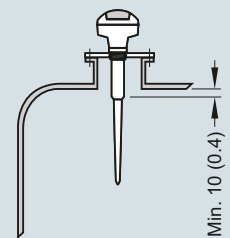

SITRANS LR200 installation, dimensions in mm (inch)

Level Measurement

Continuous level measurement
Radar transmitters

SITRANS LR200

Integration



SITRANS LR200 with flange adapter for connection to optional antennas.



Horn with waveguide extension. Used for high temperature isolation, long standpipes, and clearing tank obstructions.



Flat faced flange connection with PTFE rod antenna.



Shielded rod antenna with a stainless steel shield eliminates standpipe interference. Various lengths available.

Antenna configurations for SITRANS LR200

Antenna types	Flat Faced Flange with Rod	Shielded Rod	Horn (4", 6", 8" sizes available)
Connection type	Flat faced flange nominal pipe sizes 50, 80, 100, 150 mm (2, 3, 4, 6 inch)	Threaded 2" NPT, R 2" (BSPT), G 2" (BSPP) or flat faced flange nominal pipe sizes 80, 100 mm (3, 4 inch)	Flat faced flange nominal pipe sizes 50, 80, 100, 150 mm (2, 3, 4, 6 inch)
Wetted parts	PTFE	PTFE, 316L stainless steel, FKM O-ring	316L stainless steel PTFE, FKM O-ring
Extensions	50 or 100 mm (2 or 4 inch) PTFE or UHMW-PE	100, 150, 200 or 250 mm (4, 6, 8 or 10 inch) standard shield length	Use waveguide for extensions to 6 m (20 ft) long
Dielectric constant	> 3	> 3	> 3
Insertion length (max.)	41 cm (16.3 inch)	Variable	Variable with extension
Purging option (liquid or gas)	No	No	Yes
Sliding waveguide option for digesters¹⁾	Yes	No	Yes
Weight²⁾	6.5 kg (14.3 lb)	5.0 kg (11 lb)	7.5 kg (16.5 lb)

¹⁾ Maximum pressure 0.5 bar g at 60 °C (7.25 psi g at 140 °F)

²⁾ Not including extensions, includes SITRANS LR200 and smallest process connection

Technical specifications

Mode of operation		Power supply	
Measuring principle	Radar level measurement	4 ... 20 mA/HART	Nominal 24 V DC (max. 30 V DC) with max. 550 Ω
Frequency	C-band, approx. 6 GHz	<ul style="list-style-type: none"> General Purpose, Non-incendive, Intrinsically Safe 	
Measuring range	0.3 ... 20 m (1.0 ... 65 ft)	<ul style="list-style-type: none"> Flame proof, Increased safety, Explosion proof 	Nominal 24 V DC (max. 30 V DC) with max. 250 Ω
Output		PROFIBUS PA	<ul style="list-style-type: none"> 10.5 mA Per IEC 61158-2
Analog output	4 ... 20 mA	Certificates and approvals	
Accuracy	± 0.02 mA	General	CSA _{US/C} , CE, FM, RCM
Span	Proportional or inversely proportional	Marine	<ul style="list-style-type: none"> Lloyd's Register of Shipping ABS Type Approval
Communications	HART	Radio	FCC, Industry Canada, and European (RED), RCM
Fail-safe	Programmable as high, low or hold (Loss of Echo)	Hazardous	INMETRO Ex ia IIC T4 Ga CSA/FM, Class I, Div. 1, Groups A, B, C, D; Class II, Div. 1, Groups E, F, G; Class III, T4
Performance (according to reference conditions IEC60770-1)		<ul style="list-style-type: none"> Intrinsically Safe (Brazil) Explosion Proof (Canada/USA) 	
From end of antenna to 600 mm	40 mm (1.57 inch)	<ul style="list-style-type: none"> Intrinsically Safe (Canada/USA) 	CSA/FM, Class I, Div. 1, Groups A, B, C, D; Class II, Div. 1, Groups E, F, G; Class III, T4
Remainder of range	10 mm (0.4 inch) or 0.1 % of span (whichever is greater)	<ul style="list-style-type: none"> Non-incendive (USA) 	FM, Class I, Div. 2, Groups A, B, C, D, T5
Rated operating conditions		<ul style="list-style-type: none"> Flame Proof/Increased Safety (China) Flame Proof (Europe) 	NEPSI Ex d mb ia IIC T4/ Ex e mb ia IIC T4
Installation conditions	Indoor/outdoor	<ul style="list-style-type: none"> Increased Safety (Europe) 	ATEX II 1/2 G Ex d mb ia IIC T4 Ga/Gb
• Location		<ul style="list-style-type: none"> Intrinsically Safe (Europe) Intrinsically Safe (International) Intrinsically Safe (Russia/Kazakhstan) 	ATEX II 1/2 G Ex e mb ia IIC T4 Ga/Gb
Ambient conditions (enclosure)		<ul style="list-style-type: none"> Ambient temperature Installation category Pollution degree 	ATEX II 1G Ex ia IIC T4
• Ambient temperature			-40 ... +80 °C (-40 ... +176 °F)
• Installation category	I		EAC Ex ia
• Pollution degree	4	Programming	
Medium conditions		Intrinsically Safe Siemens handheld programmer	Infrared receiver
Dielectric constant ϵ_r	$\epsilon_r > 1.6$ (for $\epsilon_r < 3$, use stillpipe)	<ul style="list-style-type: none"> Approvals for handheld programmer 	IS model:
Vessel temperature and pressure	Varies with connection type; see Pressure/Temperature curves for more information	ATEX II 1GD Ex ia IIC T4 Ga Ex iaD 20 T135 °C T _a = -20 ... +50 °C CSA/FM Class I, II, and III, Div. 1, Groups A, B, C, D, E, F, G, T6 T _a = +50 °C	
Design		Handheld communicator	HART communicator 375
Enclosure	Aluminum, polyester powder coated 2 x M20 x 1.5 or 2 x 1/2" NPT	PC	<ul style="list-style-type: none"> SIMATIC PDM AMS SITRANS DTM (for connecting to FDT such as PACTware or Field-care)
• Material		Type 4X/NEMA 4X, Type 6/ NEMA 6, IP67, IP68	Display (local)
• Cable inlet	< 2.82 kg (6.21 lb) (polypropylene rod antenna)		
Degree of protection	Multi-segment alphanumeric liquid crystal with bar graph (representing level) available in four languages		
Weight	Polypropylene rod, hermetically sealed construction, optional PTFE		
Display (local)	Standard 100 mm (4 inch) shield for maximum 100 mm (4 inch) nozzle, or optional 250 mm (10 inch) long shield		
Antenna	Refer to SITRANS LR200 Antennas for optional rods and horns		
• Material	1 1/2" NPT [(Taper), ANSI/ASME B1.20.1]		
• Dimensions	R 1 1/2" [(BSPT), EN 10226], or		
• Optional rods and horn	G 1 1/2" [(BSPP), EN ISO 228-1] (polypropylene rod antenna)		
Process connections	Refer to SITRANS LR200 Antennas for more connections		
• Process connection			
• Flange connection			

Level Measurement

Continuous level measurement

Radar transmitters

SITRANS LR200

Selection and Ordering data

SITRANS LR200, Uni-Construction polypropylene rod antenna version

2-wire, 6 GHz pulse radar level transmitter for continuous monitoring of liquids and slurries in process vessels including high temperature and pressure, to a range of 20 m (66 ft).

Max. 3 bar g (43.5 psi g) pressure and 80 °C (176 °F)

Click on the Article No. for the online configuration in the PIA Life Cycle Portal.

Enclosure/Cable inlet

Aluminum, epoxy painted
2 x 1/2" NPT
2 x M20 x 1.5

Polypropylene antenna type - (Max. 3 Bar pressure and 80 °C)

1/2" NPT [(Taper), ANSI/ASME B1.20.1], c/w integral 100 mm shield
R 1/2" [(BSPT), EN 10226], c/w integral 100 mm shield
G 1/2" [(BSPP), EN ISO 228-1], c/w integral 100 mm shield

1/2" NPT [(Taper), ANSI/ASME B1.20.1], c/w integral 250 mm shield
R 1/2" [(BSPT), EN 10226], c/w integral 250 mm shield
G 1/2" [(BSPP), EN ISO 228-1], c/w integral 250 mm shield

Approvals

General Purpose, CE, RED, RCM
General Purpose, CSA, FM, Industry Canada, FCC
Intrinsically Safe, CSA Class I, II, Div. 1, Groups A, B, C, D, E, F, G, Industry Canada

Intrinsically Safe, FM Class I, II, Div. 1, Groups A, B, C, D, E, F, G, FCC
Intrinsically Safe, IECEx/ATEX II 1G Ex ia IIC T4, INMETRO Ex ia IIC T4, CE, RED, RCM; EAC
Non incandive, FM Class I, Div. 2, Groups A, B, C, D, FCC¹⁾

Increased Safety, ATEX II 1/2G Ex e mb ia IIC T4 Ga/Gb, CE, RED, RCM; EAC²⁾³⁾

Flame Proof, ATEX II 1/2G Ex d mb ia IIC T4 Ga/Gb, CE, RED, RCM; EAC³⁾
Explosion Proof, CSA/FM Class I, II, III, Groups A, B, C, D, E, F, G, Industry Canada, FCC¹⁾³⁾

Communication/Output

PROFIBUS PA
4 ... 20 mA, HART, start-up at < 3.6 mA

¹⁾ Available with enclosure option 2 only

²⁾ Available with enclosure option 3 only

³⁾ Available with communication option 3 only

Article No.

7ML5422-

0

2

3

A

B

C

D

E

F

A

B

C

D

E

F

G

H

J

2

3

Selection and Ordering data

Order code

Further designs

Please add "-Z" to Article No. and specify Order code(s).

Stainless steel tag [69 x 50 mm (2.71 x 1.97 inch)]:
Measuring-point number/identification (max. 27 characters); specify in plain text

Y15

Manufacturer's test certificate:
M to DIN 55350, Part 18 and to ISO 9000

C11

Namur NE43 compliant, device preset to failsafe < 3.6 mA¹⁾

N07

Operating Instructions

All literature is available to download for free, in a range of languages, at <http://www.siemens.com/processinstrumentation/documentation>

Accessories

Handheld programmer, Intrinsically safe, EEx ia

Article No.

7ML1930-1BK

HART modem/USB
(for use with a PC and SIMATIC PDM)

7MF4997-1DB

One metallic cable gland M20 x 1.5, rated -40 ... +80 °C (-40 ... +176 °F), HART²⁾

7ML1930-1AP

One metallic cable gland M20 x 1.5, rated -40 ... +80 °C (-40 ... +176 °F), PROFIBUS PA²⁾

7ML1930-1AQ

One general purpose polymeric cable gland M20 x 1.5, rated -20 ... +80 °C (-40 ... +176 °F)

7ML1930-1AM

SITRANS RD100, loop powered display - see Chapter 7

7ML5741-...

SITRANS RD200, universal input display with Modbus conversion - see Chapter 7

7ML5740-...

SITRANS RD300, dual line display with totalizer and linearization curve and Modbus conversion - see Chapter 7

7ML5744-...

SITRANS RD500 web, universal remote monitoring solution for instrumentation - see Chapter 7

7ML5750-...

For applicable back up point level switch - see point level measurement section

¹⁾ Available with communication option 3 only

²⁾ Product shipped with plastic cable gland, rated to -20 °C.

If -40 °C rating required, then metallic cable gland is recommended.

Level Measurement
Continuous level measurement
Radar transmitters

SITRANS LR200

Selection and Ordering data	Article No.
SITRANS LR200, Flange Adapter/PTFE Rod Antenna Version 2-wire, 6 GHz pulse radar level transmitter for continuous monitoring of liquids and slurries in process vessels including high temperature and pressure, to a range of 20 m (66 ft). Click on the Article No. for the online configuration in the PIA Life Cycle Portal.	7ML5423-
Antenna material (uses antenna adapter) PTFE, uses antenna adapter and additional process connection below	1
Process connection (refer to Pressure/Temperature curves, page 4/211) Flanges (316L stainless steel) DN 50 PN 16, Type A, flat faced DN 80 PN 16, Type A, flat faced DN 100 PN 16, Type A, flat faced DN 150 PN 16, Type A, flat faced 2" ASME 150 lb, flat faced 3" ASME 150 lb, flat faced 4" ASME 150 lb, flat faced 6" ASME 150 lb, flat faced DN 50 PN 40, flat faced DN 80 PN 40, flat faced DN 100 PN 40, flat faced DN 150 PN 40, flat faced 2" ASME 300 lb, flat faced, available with Pressure rating option 1 only due to flange hole spacing 3" ASME 300 lb, flat faced 4" ASME 300 lb, flat faced 6" ASME 300 lb, flat faced JIS DN 50 10K JIS DN 80 10K JIS DN 100 10K JIS DN 150 10K (Note: Flange bolting patterns and facings dimensionally correspond to the applicable ASME B16.5, or EN 1092-1, or JIS B 2220 standard.) Threaded connection (316L stainless steel) 1½" NPT [(Taper), ANSI/ASME B1.20.1] 2" NPT [(Taper), ANSI/ASME B1.20.1] R 1½" [(BSPT), EN 10226] R 2" [(BSPT), EN 10226] G 1½" [(BSPP), EN ISO 228-1] G 2" [(BSPP), EN ISO 228-1]	AA BA CA DA FB GB HB JB AC BC CC DC FD GD HD JD AE BE CE DE LA MA LC MC LE ME
Antenna extensions or Inactive shield length No antenna extension 50 mm (2 inch) extension, PTFE 100 mm (4 inch) extension, PTFE 100 mm (4 inch) extension, 316L stainless steel shield ¹⁾ 150 mm (6 inch) extension, 316L stainless steel shield ¹⁾ 200 mm (8 inch) extension, 316L stainless steel shield ¹⁾ 250 mm (10 inch) extension, 316L stainless steel shield ¹⁾	0 1 2 3 4 5 6
Process seal/gasket Integral Gasket, for flat faced flange process connections only, not for Antenna extension options 3 ... 6 FKM O-ring, not available for combination of flat faced flanges with Antenna extension options 0, 1 or 2	0 1

Selection and Ordering data	Article No.
SITRANS LR200, Flange Adapter/PTFE Rod Antenna Version 2-wire, 6 GHz pulse radar level transmitter for continuous monitoring of liquids and slurries in process vessels including high temperature and pressure, to a range of 20 m (66 ft).	7ML5423-
Enclosure/Cable inlet Aluminum, Epoxy painted 2 x ½" NPT 2 x M20 x 1.5	2 3
Communication/Output PROFIBUS PA 4 ... 20 mA, HART, start-up at < 3.6 mA	B C
Approvals General Purpose, CE, RED, RCM General Purpose, CSA FM, Industry Canada, FCC Intrinsically Safe, CSA Class I, II, Div. 1, Groups A, B, C, D, E, F, G, Industry Canada Intrinsically Safe, FM Class I, II, Div. 1, Groups A, B, C, D, E, F, G, FCC Intrinsically Safe, IECEx/ATEX II 1G Ex ia IIC T4, INMETRO Ex ia IIC T4, CE, RED, RCM; EAC Non incensive, FM Class I, Div. 2, Groups A, B, C, D, FCC ²⁾ Increased Safety, ATEX II 1/2G Ex e mb ia IIC T4 Ga/Gb, CE, RED, RCM; EAC ³⁾⁴⁾ Flame Proof, ATEX II 1/2G Ex d mb ia IIC T4 Ga/ Gb, CE, RED, RCM; EAC ⁴⁾ Explosion Proof, CSA/FM Class I, II, III, Groups A, B, C, D, E, F, G, Industry Canada, FCC ²⁾⁴⁾	A B C D E F G H J
Pressure rating Rating per Pressure/Temperature curves in manual 0.5 bar g (7.25 psi g) maximum	0 1
¹⁾ Available with process connection options BA, CA, DA, GB, HB, JB, BC, CC, DC, GD, HD, JD, BE, CE, DE, MA, MC, ME only ²⁾ Available with enclosure option 2 only ³⁾ Available with enclosure option 3 only ⁴⁾ Available with communication option C only	



Level Measurement

Continuous level measurement
Radar transmitters

SITRANS LR200

Selection and Ordering data	Order code
Further designs	
Please add "-Z" to Article No. and specify Order code(s).	
Stainless steel tag [69 x 50 mm (2.71 x 1.97 inch)]; Measuring-point number/identification (max. 27 characters); specify in plain text	Y15
Manufacturer's test certificate: M to DIN 55350, Part 18 and to ISO 9000	C11
Material inspection Certificate Type 3.1 per EN 10204	C12
Namur NE43 compliant, device preset to failsafe < 3.6 mA ³⁾	N07
Operating Instructions	
All literature is available to download for free, in a range of languages, at http://www.siemens.com/processinstrumentation/documentation	
Accessories	
Handheld programmer, Intrinsically safe, EEx ia	7ML1930-1BK
Antenna, rod, PTFE	7ML1830-1HC
Antenna extension, 50 mm (2 inch), PTFE	7ML1830-1CH
Antenna extension, 100 mm (4 inch), PTFE	7ML1830-1CG
HART modem / USB (for use with PC and SIMATIC PDM)	7MF4997-1DB
Metallic cable gland M20 x 1.5, rated -40 °C (-40 °F) ... 80 °C (176 °F), HART (two are required)	7ML1930-1AP
Metallic cable gland M20 x 1.5, rated -40 °C (-40 °F) ... 80 °C (176 °F), PROFIBUS PA (two required)	7ML1930-1AQ
One General Purpose polymeric cable gland M20 x 1.5, rating for -20 °C (-4°F) ... + 80 °C (176 °F)	7ML1930-1AM
SITRANS RD100, loop powered display - see Chapter 7	7ML5741-...
SITRANS RD200, universal input display with Modbus conversion - see Chapter 7	7ML5740-...
SITRANS RD300, dual line display with totalizer and linearization curve and Modbus conversion - see Chapter 7	7ML5744-...
SITRANS RD500 web, universal remote monitoring solution for instrumentation - see Chapter 7	7ML5750-...
For applicable back up point level switch - see point level measurement section	

Selection and Ordering data	Article No.
SITRANS LR200, Flange adapter/Horn Antenna version	7ML5425-
2-wire, 6 GHz pulse radar level transmitter for continuous monitoring of liquids and slurries in process vessels including high temperature and pressure, to a range of 20 m (66 ft).	
Click on the Article No. for the online configuration in the PIA Life Cycle Portal.	
Antenna material (uses antenna adapter)	
316L stainless steel with PTFE cone emitter	0
316L stainless steel with PTFE cone emitter and purge connection with 1/8" NPT inlet ¹⁾	1
Process connection (refer to Pressure/Temperature curves, page 4/211)	
Flanges (316L stainless steel)	
DN 50 PN 16 EN 1092-1 Type A flat faced ¹⁾	AA
DN 80 PN 16 EN 1092-1 Type A flat faced	BA
DN 100 PN 16 EN 1092-1 Type A flat faced	CA
DN 150 PN 16 EN 1092-1 Type A flat faced	DA
DN 200 PN 16 EN 1092-1 Type A flat faced	EA
DN 80 PN 10/16 DIN EN 1092-1 Type B1 raised face ²⁾	BF
DN 100 PN 10/16 DIN EN 1092-1 Type B1 raised face ³⁾	CF
DN 150 PN 10/16 DIN EN 1092-1 Type B1 raised face ³⁾	DF
DN 200 PN 16 DIN EN 1092-1 Type B1 raised face ³⁾	EF
2" ASME 150 lb, flat faced ¹⁾	FB
3" ASME 150 lb, flat faced	GB
4" ASME 150 lb, flat faced	HB
6" ASME 150 lb, flat faced	JB
8" ASME 150 lb, flat faced	KB
DN 50 PN 40, flat faced ³⁾	AC
DN 80 PN 40, flat faced ³⁾	BC
DN 100 PN 40, flat faced ³⁾	CC
DN 80 PN 25/40 DIN EN 1092-1 Type B1 raised face ³⁾	CG
DN 100 PN 25/40 DIN EN 1092-1 Type B1 raised face ³⁾	DG
DN 150 PN 25/40 DIN EN 1092-1 Type B1 raised face ³⁾	EG
2" ASME 300 lb, flat faced ¹⁾³⁾	FD
3" ASME 300 lb, flat faced ³⁾	GD
4" ASME 300 lb, flat faced ³⁾	HD
JIS DN 50 10K ¹⁾	AE
JIS DN 80 10K	BE
JIS DN 100 10K	CE
JIS DN 150 10K	DE
JIS DN 200 10K	EE
(Note: Flange bolting patterns and facings dimensionally correspond to the applicable ASME B16.5, or EN 1092-1, or JIS B 2220 standard.)	
Communication/Output	
PROFIBUS PA	1
4 ... 20 mA, HART, start-up at < 3.6 mA	2

Selection and Ordering data	Article No.
SITRANS LR200, Flange adapter/Horn Antenna version	7ML5425-
2-wire, 6 GHz pulse radar level transmitter for continuous monitoring of liquids and slurries in process vessels including high temperature and pressure, to a range of 20 m (66 ft).	
Process seal/gasket	
FKM (-40 ... +200 °C)	0
Nitrile (-40 ... +60 °C)	1
Enclosure/Cable inlet	
Aluminum, Epoxy painted	
2 x 1/2" NPT	2
2 x M20 x 1.5	3
Horn size/Waveguide options	
80 mm (3 inch) horn ³⁾	B
100 mm (4 inch) horn ⁴⁾	C
150 mm (6 inch) horn	D
200 mm (8 inch) horn	E
100 mm (4 inch) horn with 100 mm (4 inch) waveguide extension ⁴⁾	F
100 mm (4 inch) horn with 150 mm (6 inch) waveguide extension ⁴⁾	G
100 mm (4 inch) horn with 200 mm (8 inch) waveguide extension ⁴⁾	H
100 mm (4 inch) horn with 250 mm (10 inch) waveguide extension ⁴⁾	J
150 mm (6 inch) horn with 100 mm (4 inch) waveguide extension	K
150 mm (6 inch) horn with 150 mm (6 inch) waveguide extension	L
150 mm (6 inch) horn with 200 mm (8 inch) waveguide extension	M
150 mm (6 inch) horn with 250 mm (10 inch) waveguide extension	N
200 mm (8 inch) horn with 100 mm (4 inch) waveguide extension	P
200 mm (8 inch) horn with 150 mm (6 inch) waveguide extension	Q
200 mm (8 inch) horn with 200 mm (8 inch) waveguide extension	R
200 mm (8 inch) horn with 250 mm (10 inch) waveguide extension	S



Level Measurement

Continuous level measurement

Radar transmitters

SITRANS LR200

Selection and Ordering data

SITRANS LR200,

Flange adapter/Horn Antenna version

2-wire, 6 GHz pulse radar level transmitter for continuous monitoring of liquids and slurries in process vessels including high temperature and pressure, to a range of 20 m (66 ft).

Approvals

General Purpose, CE, RED, RCM
General Purpose, CSA, FM, Industry Canada, FCC
Intrinsically Safe, CSA Class I, II, Div. 1,
Groups A, B, C, D, E, F, G, Industry Canada

Intrinsically Safe, FM Class I, II, Div. 1,
Groups A, B, C, D, E, F, G, FCC

Intrinsically Safe, IECEx/ATEX II 1G Ex ia IIC T4,
INMETRO Ex ia IIC T4, CE, RED, RCM; EAC

Non incandive, FM Class I, Div. 2,
Groups A, B, C, D, FCC⁴⁾

Increased Safety, ATEX II 1/2G Ex e mb ia IIC T4
Ga/Gb, CE, RED, RCM; EAC⁵⁾⁶⁾

Flame Proof, ATEX II 1/2G Ex d mb ia IIC T4 Ga/Gb,
CE, RED, RCM; EAC⁶⁾

Explosion Proof, CSA/FM Class I, II, III, Groups A,
B, C, D, E, F, G, Industry Canada, FCC⁵⁾⁶⁾

Explosion Proof, CSA/FM Class I, II, III, Groups A,
B, C, D, E, F, G, Industry Canada, FCC⁵⁾⁶⁾

Explosion Proof, CSA/FM Class I, II, III, Groups A,
B, C, D, E, F, G, Industry Canada, FCC⁵⁾⁶⁾

Explosion Proof, CSA/FM Class I, II, III, Groups A,
B, C, D, E, F, G, Industry Canada, FCC⁵⁾⁶⁾

Explosion Proof, CSA/FM Class I, II, III, Groups A,
B, C, D, E, F, G, Industry Canada, FCC⁵⁾⁶⁾

Explosion Proof, CSA/FM Class I, II, III, Groups A,
B, C, D, E, F, G, Industry Canada, FCC⁵⁾⁶⁾

Explosion Proof, CSA/FM Class I, II, III, Groups A,
B, C, D, E, F, G, Industry Canada, FCC⁵⁾⁶⁾

Explosion Proof, CSA/FM Class I, II, III, Groups A,
B, C, D, E, F, G, Industry Canada, FCC⁵⁾⁶⁾

Explosion Proof, CSA/FM Class I, II, III, Groups A,
B, C, D, E, F, G, Industry Canada, FCC⁵⁾⁶⁾

Explosion Proof, CSA/FM Class I, II, III, Groups A,
B, C, D, E, F, G, Industry Canada, FCC⁵⁾⁶⁾

Explosion Proof, CSA/FM Class I, II, III, Groups A,
B, C, D, E, F, G, Industry Canada, FCC⁵⁾⁶⁾

Explosion Proof, CSA/FM Class I, II, III, Groups A,
B, C, D, E, F, G, Industry Canada, FCC⁵⁾⁶⁾

Explosion Proof, CSA/FM Class I, II, III, Groups A,
B, C, D, E, F, G, Industry Canada, FCC⁵⁾⁶⁾

Explosion Proof, CSA/FM Class I, II, III, Groups A,
B, C, D, E, F, G, Industry Canada, FCC⁵⁾⁶⁾

Explosion Proof, CSA/FM Class I, II, III, Groups A,
B, C, D, E, F, G, Industry Canada, FCC⁵⁾⁶⁾

Explosion Proof, CSA/FM Class I, II, III, Groups A,
B, C, D, E, F, G, Industry Canada, FCC⁵⁾⁶⁾

Explosion Proof, CSA/FM Class I, II, III, Groups A,
B, C, D, E, F, G, Industry Canada, FCC⁵⁾⁶⁾

Explosion Proof, CSA/FM Class I, II, III, Groups A,
B, C, D, E, F, G, Industry Canada, FCC⁵⁾⁶⁾

Explosion Proof, CSA/FM Class I, II, III, Groups A,
B, C, D, E, F, G, Industry Canada, FCC⁵⁾⁶⁾

Explosion Proof, CSA/FM Class I, II, III, Groups A,
B, C, D, E, F, G, Industry Canada, FCC⁵⁾⁶⁾

Explosion Proof, CSA/FM Class I, II, III, Groups A,
B, C, D, E, F, G, Industry Canada, FCC⁵⁾⁶⁾

Explosion Proof, CSA/FM Class I, II, III, Groups A,
B, C, D, E, F, G, Industry Canada, FCC⁵⁾⁶⁾

Explosion Proof, CSA/FM Class I, II, III, Groups A,
B, C, D, E, F, G, Industry Canada, FCC⁵⁾⁶⁾

Explosion Proof, CSA/FM Class I, II, III, Groups A,
B, C, D, E, F, G, Industry Canada, FCC⁵⁾⁶⁾

Explosion Proof, CSA/FM Class I, II, III, Groups A,
B, C, D, E, F, G, Industry Canada, FCC⁵⁾⁶⁾

Explosion Proof, CSA/FM Class I, II, III, Groups A,
B, C, D, E, F, G, Industry Canada, FCC⁵⁾⁶⁾

Explosion Proof, CSA/FM Class I, II, III, Groups A,
B, C, D, E, F, G, Industry Canada, FCC⁵⁾⁶⁾

Explosion Proof, CSA/FM Class I, II, III, Groups A,
B, C, D, E, F, G, Industry Canada, FCC⁵⁾⁶⁾

Explosion Proof, CSA/FM Class I, II, III, Groups A,
B, C, D, E, F, G, Industry Canada, FCC⁵⁾⁶⁾

Explosion Proof, CSA/FM Class I, II, III, Groups A,
B, C, D, E, F, G, Industry Canada, FCC⁵⁾⁶⁾

Explosion Proof, CSA/FM Class I, II, III, Groups A,
B, C, D, E, F, G, Industry Canada, FCC⁵⁾⁶⁾

Explosion Proof, CSA/FM Class I, II, III, Groups A,
B, C, D, E, F, G, Industry Canada, FCC⁵⁾⁶⁾

Explosion Proof, CSA/FM Class I, II, III, Groups A,
B, C, D, E, F, G, Industry Canada, FCC⁵⁾⁶⁾

Explosion Proof, CSA/FM Class I, II, III, Groups A,
B, C, D, E, F, G, Industry Canada, FCC⁵⁾⁶⁾

Explosion Proof, CSA/FM Class I, II, III, Groups A,
B, C, D, E, F, G, Industry Canada, FCC⁵⁾⁶⁾

Explosion Proof, CSA/FM Class I, II, III, Groups A,
B, C, D, E, F, G, Industry Canada, FCC⁵⁾⁶⁾

Explosion Proof, CSA/FM Class I, II, III, Groups A,
B, C, D, E, F, G, Industry Canada, FCC⁵⁾⁶⁾

Explosion Proof, CSA/FM Class I, II, III, Groups A,
B, C, D, E, F, G, Industry Canada, FCC⁵⁾⁶⁾

Explosion Proof, CSA/FM Class I, II, III, Groups A,
B, C, D, E, F, G, Industry Canada, FCC⁵⁾⁶⁾

Explosion Proof, CSA/FM Class I, II, III, Groups A,
B, C, D, E, F, G, Industry Canada, FCC⁵⁾⁶⁾

Explosion Proof, CSA/FM Class I, II, III, Groups A,
B, C, D, E, F, G, Industry Canada, FCC⁵⁾⁶⁾

Explosion Proof, CSA/FM Class I, II, III, Groups A,
B, C, D, E, F, G, Industry Canada, FCC⁵⁾⁶⁾

Explosion Proof, CSA/FM Class I, II, III, Groups A,
B, C, D, E, F, G, Industry Canada, FCC⁵⁾⁶⁾

Explosion Proof, CSA/FM Class I, II, III, Groups A,
B, C, D, E, F, G, Industry Canada, FCC⁵⁾⁶⁾

Explosion Proof, CSA/FM Class I, II, III, Groups A,
B, C, D, E, F, G, Industry Canada, FCC⁵⁾⁶⁾

Explosion Proof, CSA/FM Class I, II, III, Groups A,
B, C, D, E, F, G, Industry Canada, FCC⁵⁾⁶⁾

Explosion Proof, CSA/FM Class I, II, III, Groups A,
B, C, D, E, F, G, Industry Canada, FCC⁵⁾⁶⁾

Explosion Proof, CSA/FM Class I, II, III, Groups A,
B, C, D, E, F, G, Industry Canada, FCC⁵⁾⁶⁾

Explosion Proof, CSA/FM Class I, II, III, Groups A,
B, C, D, E, F, G, Industry Canada, FCC⁵⁾⁶⁾

Explosion Proof, CSA/FM Class I, II, III, Groups A,
B, C, D, E, F, G, Industry Canada, FCC⁵⁾⁶⁾

Explosion Proof, CSA/FM Class I, II, III, Groups A,
B, C, D, E, F, G, Industry Canada, FCC⁵⁾⁶⁾

Explosion Proof, CSA/FM Class I, II, III, Groups A,
B, C, D, E, F, G, Industry Canada, FCC⁵⁾⁶⁾

Explosion Proof, CSA/FM Class I, II, III, Groups A,
B, C, D, E, F, G, Industry Canada, FCC⁵⁾⁶⁾

Explosion Proof, CSA/FM Class I, II, III, Groups A,
B, C, D, E, F, G, Industry Canada, FCC⁵⁾⁶⁾

Explosion Proof, CSA/FM Class I, II, III, Groups A,
B, C, D, E, F, G, Industry Canada, FCC⁵⁾⁶⁾

Explosion Proof, CSA/FM Class I, II, III, Groups A,
B, C, D, E, F, G, Industry Canada, FCC⁵⁾⁶⁾

Explosion Proof, CSA/FM Class I, II, III, Groups A,
B, C, D, E, F, G, Industry Canada, FCC⁵⁾⁶⁾

Explosion Proof, CSA/FM Class I, II, III, Groups A,
B, C, D, E, F, G, Industry Canada, FCC⁵⁾⁶⁾

Explosion Proof, CSA/FM Class I, II, III, Groups A,
B, C, D, E, F, G, Industry Canada, FCC⁵⁾⁶⁾

Explosion Proof, CSA/FM Class I, II, III, Groups A,
B, C, D, E, F, G, Industry Canada, FCC⁵⁾⁶⁾

Article No.

7ML5425-

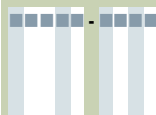

A
B
C
D
E
F
G
H
J
0
1

Selection and Ordering data

Further designs

Please add "-Z" to Article No. and specify Order code(s).

Stainless steel tag [69 x 50 mm (2.71 x 1.97 inch)]:
Measuring-point number/identification
(max. 27 characters); specify in plain text

Manufacturer's test certificate:
M to DIN 55350, Part 18 and to ISO 9000

Material inspection Certificate Type 3.1 per
EN 10204

Namur NE43 compliant, device preset to failsafe
< 3.6 mA¹⁾

Operating Instructions

All literature is available to download for free, in a
range of languages, at <http://www.siemens.com/processinstrumentation/documentation>

Accessories

Handheld programmer, Intrinsically safe, EEx ia
HART modem/USB

(for use with a PC and SIMATIC PDM)

One metallic cable gland M20 x 1.5,
rated -40 ... +80 °C (-40 ... +176 °F), HART²⁾

One metallic cable gland M20 x 1.5,
rated -40 ... +80 °C (-40 ... +176 °F), PROFIBUS PA³⁾

One general purpose polymeric cable gland
M20 x 1.5, rated -40 ... +80 °C (-40 ... +176 °F)

SITRANS RD100, loop powered display -
see Chapter 7

SITRANS RD200, universal input display with
Modbus conversion - see Chapter 7

SITRANS RD300, dual line display with totalizer
and linearization curve and Modbus conversion -
see Chapter 7

SITRANS RD500 web, universal remote monitoring
solution for instrumentation - see Chapter 7

For applicable back up point level switch -
see point level measurement section

¹⁾ Available with communication option 2 only

²⁾ Product shipped with plastic cable gland, rated to -20 °C.
If -40 °C rating required, then metallic cable gland is recommended.

³⁾ Available with enclosure option 2 only

Order code

Y15

C11

C12

N07

Article No.

7ML1930-1BK

7MF4997-1DB

7ML1930-1AP

7ML1930-1AQ

7ML1930-1AM

7ML5741-...

7ML5740-...

7ML5744-...

7ML5750-...

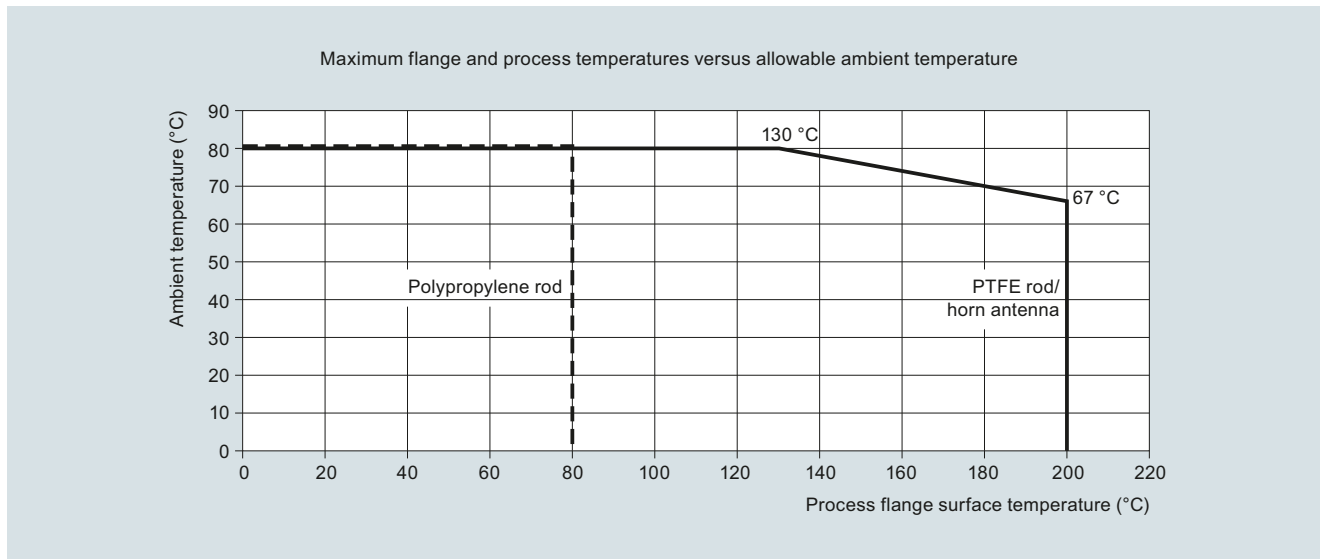
Characteristic curves

SITRANS LR200 ambient/process flange surface temperature curve

Level Measurement

Continuous level measurement
Radar transmitters

SITRANS LR200

4

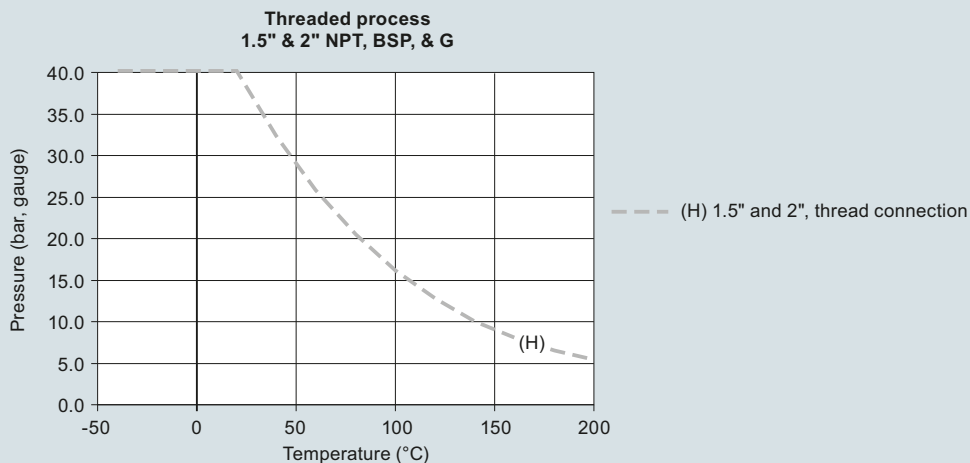
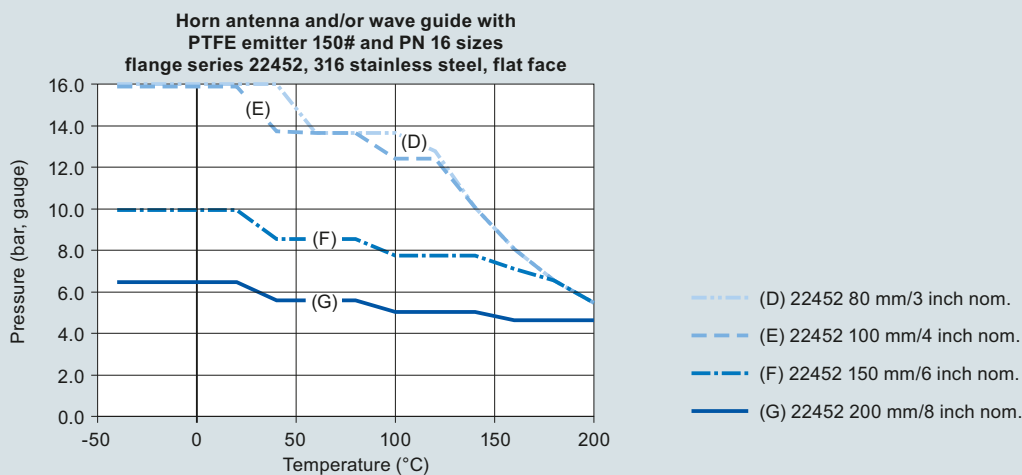
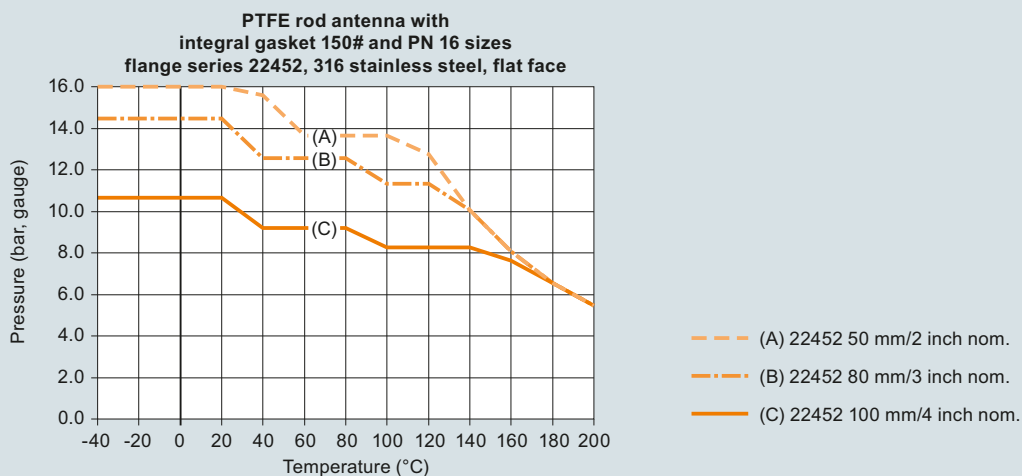

SITRANS LR200 process pressure/temperature derating curves

Dimensional drawings

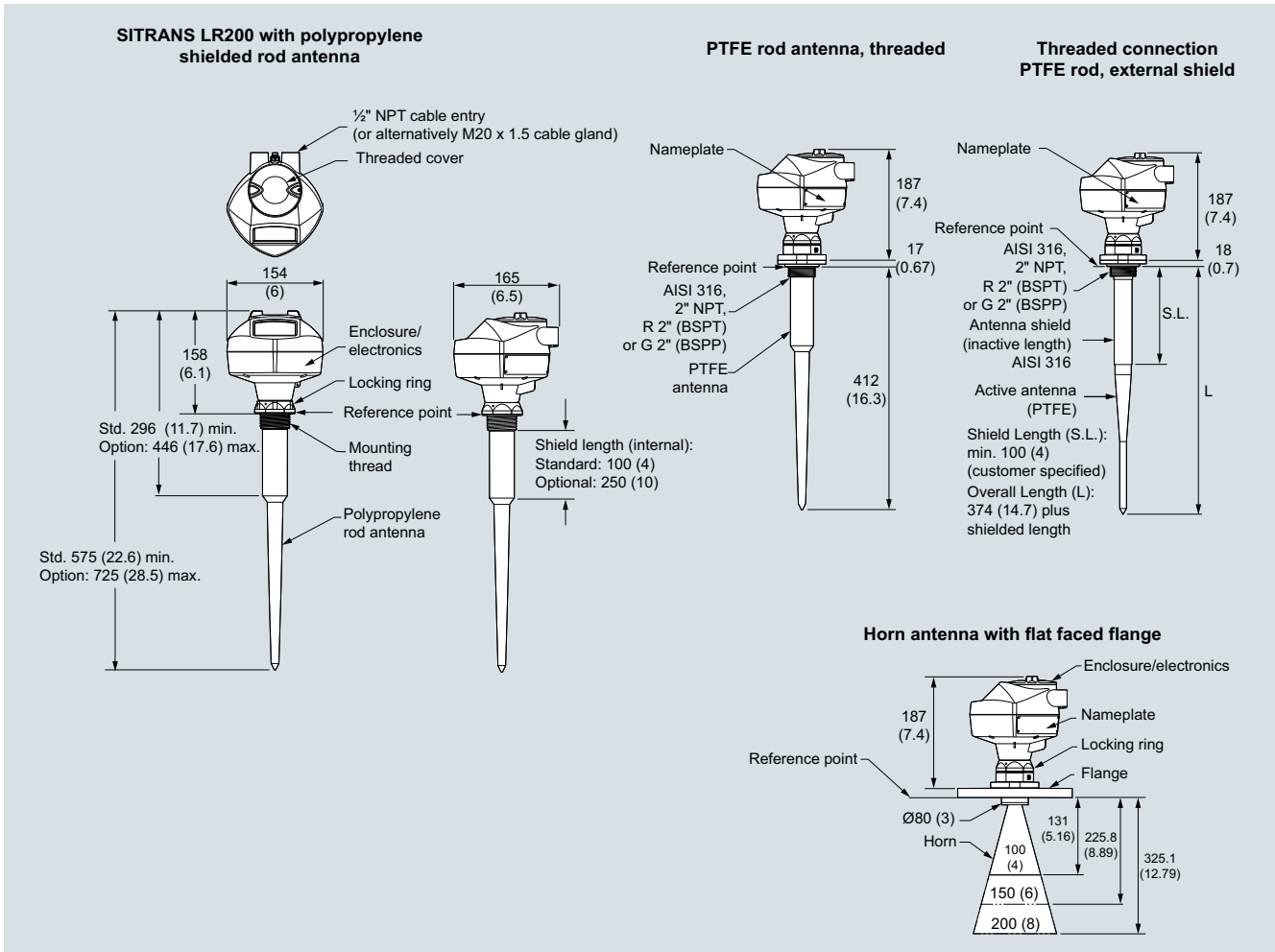

SITRANS LR200, dimensions in mm (inch)

Level Measurement

Continuous level measurement
Radar transmitters

SITRANS LR200

Circuit diagrams

4

Connect the wires to the terminals as shown: the polarity is identified on the terminal block.

Gland may or may not be provided, depending on approval option.

Shield for HART and PROFIBUS PA intrinsically safe versions only.

Hand programmer

SIEMENS			
1	2	3	4
5	6	7	8
9	0	.	+/−
C	⏪	⏩	⏴
←	↑	↓	→





Part number:
7ML1930-1BK

Notes:

1. DC terminal shall be supplied from an SELV source in accordance with IEC 1010-1 Annex H.
2. All field wiring must have insulation suitable for rated input voltages.
3. Use shielded twisted pair cable (14 ... 22 AWG) for HART version.
4. Separate cables and conduit may be required to conform to standard instrumentation wiring practices or electrical codes.

SITRANS LR200 connections

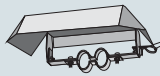
Selection and ordering data



SITRANS LR200 Specials		SITRANS LR200 Specials	
	Article No.		Article No.
SITRANS LR200 PROFIBUS PA Aluminum Enclosure Kit with electronics and covers (7ML5422, 7ML5423, 7ML5424, 7ML5425), calibrated for use with standard rod antenna		SITRANS LR200 aluminum enclosure with board stack, LUI display, 5.8 GHz, NPT cable inlet, approval option A, with HART communication start-up at < 3.6 mA, no process connection.	A5E03617085
	A5E01483420	SITRANS LR200 aluminum enclosure with board stack, LUI display, 6.3 GHz, NPT cable inlet, approval option B, with HART communication start-up at < 3.6 mA, no process connection.	A5E03617086
	A5E01483440	SITRANS LR200 aluminum enclosure with board stack, LUI display, 5.8 GHz, M20 cable inlet, approval option A, with PROFIBUS PA communication, no process connection.	A5E03617087
	A5E01483456	SITRANS LR200 aluminum enclosure with board stack, LUI display, 6.3 GHz, M20 cable inlet, approval option C, with HART communication start-up at < 3.6 mA, no process connection.	A5E03617088
	A5E01483547	SITRANS LR200 aluminum enclosure with board stack, LUI display, 6.3 GHz, NPT cable inlet, approval option C, with PROFIBUS PA communication, no process connection.	
SITRANS LR200 HART aluminum enclosure kit with electronics and covers (7ML5422, 7ML5423, 7ML5424, 7ML5425), calibrated for use with standard rod antenna		SITRANS LR200 aluminum enclosure with board stack, LUI display, 5.8 GHz, NPT cable inlet, approval option E, with PROFIBUS PA communication, no process connection.	A5E039142556
	A5E01483559	Sun shield for SITRANS LR200 enclosure, stainless steel	
		SITRANS LR200 Horn Antenna Kits with mounting screws (no emitter supplied)	
	A5E02956419	80 mm (3 inch) horn antenna kit	PBD:25500K02A
	A5E02956420	100 mm (4 inch) horn antenna kit	PBD:25500K03A
A5E02956421	150 mm (6 inch) horn antenna kit	PBD:25500K05A	
A5E02956422	SITRANS LR200 Extension Kits for Horn Antenna with mounting screws		
	100 mm (4 inch) extension kit for horn antenna	PBD:25501K0100A	
	150 mm (6 inch) extension kit for horn antenna	PBD:25501K0150A	
	200 mm (8 inch) extension kit for horn antenna	PBD:25501K0200A	
	250 mm (10 inch) extension kit for horn antenna	PBD:25501K0250A	
	500 mm (20 inch) extension kit for horn antenna	PBD:25501K0500A	
	1 000 mm (40 inch) extension kit for horn antenna	PBD:25501K1000A	

Level Measurement

Continuous level measurement
Radar transmitters

SITRANS LR200 Specials

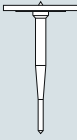
4

SITRANS LR200 Specials	
	Article No.
<p>SITRANS LR200 Flanged Rod Antenna Kit with 316L stainless steel flat faced flanges</p>  <p>Flanged PTFE rod antenna kit, 2" ASME, 150 lb. See drawing 51003 on http://www.siemens.com/radar ¹⁾⁴⁾</p> <p>Flanged PTFE rod antenna kit, DN 50 PN 16. See drawing 51003 on http://www.siemens.com/radar ¹⁾⁴⁾</p> <p>Flanged PTFE rod antenna kit, JIS 10K DN 50. See drawing 51003 on http://www.siemens.com/radar ¹⁾⁴⁾</p>	<p>PBD: 51003K020AAAA</p> <p>PBD: 51003K050AJAA</p> <p>PBD: 51003K050AOAA</p>
<p>SITRANS LR200 PTFE Rod Antenna Kit with 316L stainless steel 1½" pipe thread process connection</p>  <p>PTFE rod antenna kit, R 1½" (BSPT), EN 10226 316L stainless steel process connection, FKM O-ring; see drawing 51004 on http://www.siemens.com/radar ⁴⁾</p> <p>PTFE rod antenna kit, 1½" G 316L stainless steel process connection, FKM O-ring; see drawing 51004 on http://www.siemens.com/radar ⁴⁾</p>	<p>PBD: 51004K2AAA</p> <p>PBD: 51004K3AAA</p>
<p>SITRANS LR200 PTFE Rod Antenna Kit with 316L stainless steel 2" pipe thread process connection</p>  <p>PTFE rod antenna kit, 2" NPT 316L stainless steel process connection, FKM O-ring; see drawing 51005 on http://www.siemens.com/radar ⁴⁾</p> <p>PTFE rod antenna kit, R 2" (BSPT), EN 10226 316L stainless steel process connection, FKM O-ring; see drawing 51005 on http://www.siemens.com/radar ⁴⁾</p> <p>PTFE rod antenna kit, 2" G 316L stainless steel process connection, FKM O-ring; see drawing 51005 on http://www.siemens.com/radar ⁴⁾</p>	<p>PBD: 51005K1AAA</p> <p>PBD: 51005K2AAA</p> <p>PBD: 51005K3AAA</p>

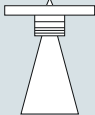
SITRANS LR200 Specials	
	Article No.
<p>SITRANS LR200 PTFE Rod Antenna Kit (100 mm shield) with 316L stainless steel 2" pipe thread process connection</p>  <p>PTFE rod antenna shielded kit, 2" NPT 316L stainless steel process connection, FKM O-ring, 100 mm 316L stainless steel shield. See drawing 51002 on http://www.siemens.com/radar ³⁾⁴⁾</p> <p>PTFE rod antenna shielded kit, R 2" (BSPT), EN 10226 316L stainless steel process connection, FKM O-ring, 100 mm 316L stainless steel shield. See drawing 51002 on http://www.siemens.com/radar ³⁾⁴⁾</p> <p>PTFE rod antenna shielded kit, 2" G 316L stainless steel process connection, FKM O-ring, 100 mm 316L stainless steel shield. See drawing 51002 on http://www.siemens.com/radar ³⁾⁴⁾</p>	<p>PBD: 51002K0100AAA</p> <p>PBD: 51002K0100BAA</p> <p>PBD: 51002K0100CAA</p>
<p>SITRANS LR200 Horn Antenna Kit with 316L stainless steel flat faced flange, with PTFE emitter (without waveguide)</p>  <p>Horn antenna kit, 2" ASME 316L stainless steel flange 3 inch horn, PTFE emitter¹⁾⁴⁾</p> <p>Horn antenna kit, 2" ASME 316L stainless steel flange 4 inch horn, PTFE emitter¹⁾²⁾</p> <p>Horn antenna kit, 2" ASME 316L stainless steel flange 6 inch horn, PTFE emitter¹⁾²⁾</p> <p>Horn antenna kit, 2" ASME 316L stainless steel flange 8 inch horn, PTFE emitter¹⁾²⁾</p> <p>Horn antenna kit, DN 50 PN 16 316L stainless steel flange 80 mm horn, PTFE emitter¹⁾²⁾</p> <p>Horn antenna kit, DN 50 PN 16 316L stainless steel flange 100 mm horn, PTFE emitter¹⁾²⁾</p> <p>Horn antenna kit, DN 50 PN 16 316L stainless steel flange 150 mm horn, PTFE emitter¹⁾²⁾</p> <p>Horn antenna kit, DN 50 PN 16 316L stainless steel flange 200 mm horn, PTFE emitter¹⁾²⁾</p>	<p>PBD: 51006K020AAAA</p> <p>PBD: 51006K020AABA</p> <p>PBD: 51006K020AACA</p> <p>PBD: 51006K020AADA</p> <p>PBD: 51006K050AJAA</p> <p>PBD: 51006K050AJBA</p> <p>PBD: 51006K050AJCA</p> <p>PBD: 51006K050AJDA</p>

SITRANS LR200 Specials	
	Article No.
SITRANS LR200 PTFE flanged rod antenna kit with 316L stainless steel shield and 316L stainless steel flat faced flange	
PTFE shielded rod antenna kit, flanged, 3" ASME 150 lb 316L stainless steel flange, 100 mm 316L stainless steel shield. ¹⁾⁴⁾	PBD: 51014K0100AAA
PTFE shielded rod antenna kit, flanged, DN 80 PN 16 316L stainless steel flange, 100 mm 316L stainless steel shield. ¹⁾⁴⁾	PBD: 51014K0100EJA
PTFE shielded rod antenna kit, flanged, 3" ASME 150 lb 316L stainless steel flange, 150 mm 316L stainless steel shield. ¹⁾⁴⁾	PBD: 51014K0150AAA
PTFE shielded rod antenna kit, flanged, DN 80 PN 16 316L stainless steel flange, 150 mm 316L stainless steel shield. ¹⁾⁴⁾	PBD: 51014K0150EJA
PTFE shielded rod antenna kit, flanged, 3" ASME 150 lb 316L stainless steel flange, 200 mm 316L stainless steel shield. ¹⁾⁴⁾	PBD: 51014K0200AAA
PTFE shielded rod antenna kit, flanged, DN 80 PN 16 316L stainless steel flange, 200 mm 316L stainless steel shield. ¹⁾⁴⁾	PBD: 51014K0200EJA
PTFE shielded rod antenna kit, flanged, 3" ASME 150 lb 316L stainless steel flange, 250 mm 316L stainless steel shield. ¹⁾⁴⁾	PBD: 51014K0250AAA
PTFE shielded rod antenna kit, flanged, DN 80 PN 16 316L stainless steel flange, 250 mm 316L stainless steel shield. ¹⁾⁴⁾	PBD: 51014K0250EJA
PTFE grease	
Kit, PTFE grease, 5 Dupont 1 GR Polypack	A5E01151626
Cable gland	
One metallic cable gland M20 x 1.5, rated -40 ... +80 °C (-40 ... +176 °F), HART	7ML1930-1AP
One metallic cable gland M20 x 1.5, rated -40 ... +80 °C (-40 ... +176 °F), PROFIBUS PA	7ML1930-1AQ
Ex-proof plugs	
Ex-proof plugs kit, 1/2" NPT, qty 5	A5E39979991
Ex-proof plugs kit, M20, qty 5	A5E39979992

1) Available in flange sizes including ASME, DIN and JIS.
Please consult a local sales person for details.

2) Available with no pressure rating.
Please consult a local sales person for details.

3) Available in other shield lengths.
Please consult a local sales person for details.

4) Available with Pressure rating.
Please consult a local sales person for details.

Customers interested in a custom designed device should consult a local sales person. For more information, please visit http://www.automation.siemens.com/aspa_app.