

Level Measurement

Continuous level measurement
Radar transmitters

SITRANS LR250 Threaded PVDF Antenna

Overview



SITRANS LR250 with threaded PVDF antenna is a 2-wire, 25 GHz pulse radar level transmitter for continuous monitoring of liquids and slurries in storage and process vessels including corrosives or aggressive materials, to a range of 10 m (32.8 ft) or 20 m (66 ft) when used in a stilling pipe.

Benefits

- Fully insulated PVDF antenna design for use in chemical and sanitary environments where aggressive and corrosive materials are used
- Graphical local user interface (LUI) makes operation simple with plug-and-play setup using the intuitive Quick Start Wizard
- LUI displays echo profiles for diagnostic support
- 25 GHz high frequency and 50 mm (2 inch) process connection/antenna allow for easy mounting in nozzles
- Communication using HART or PROFIBUS PA, or FOUNDATION Fieldbus
- Process Intelligence signal processing for improved measurement reliability and Auto False-Echo Suppression of fixed obstructions
- Programming using infrared Intrinsically Safe handheld programmer or over a network using SIMATIC PDM, Emerson AMS, or Field Device Tools such as PACTware or Fieldcare via SITRANS DTM
- Suitable for use in Safety Related Systems in accordance with IEC 61508/61511 (SIL-2)
- 3 mm (0.118 inch) accuracy in accordance with IEC 60770-1

Application

SITRANS LR250 includes a graphical local user interface (LUI) that improves setup and operation by including an intuitive Quick Start Wizard, and echo profile displays for diagnostic support. Startup is easy using the Quick Start wizard with a few parameters required for basic operation.

SITRANS LR250's unique design allows safe and simple programming using the Intrinsically Safe handheld programmer without having to open the instrument's lid.

SITRANS LR250 measures superbly in small vessels and in tanks/vessels up to 10 m (32 ft) on materials with $dk > 3$ or 20 m (66 ft) when used in a stilling pipe with $dk \geq 1.6$.

- Key Applications: liquid bulk storage tanks, process vessels with agitators, vaporous liquids, temperatures to 80 °C (176 °F), corrosive and aggressive materials and applications requiring functional safety

Configuration

Installation

Note:

- Beam angle is the width of the cone where the energy density is half of the peak energy density.
- The peak energy density is directly in front of and in line with the antenna.
- There is a signal transmitted outside of the beam angle; therefore false targets may be detected.

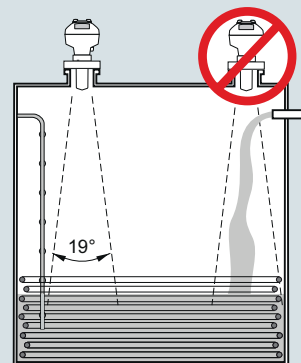

Mounting on bypass

Orient front or back of device toward vent.

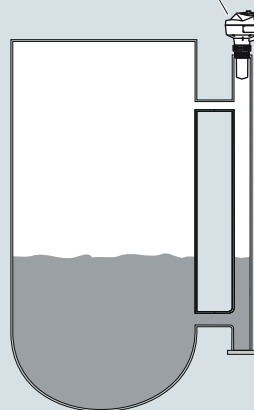

Mounting on stilling well

Orient front or back of device toward stillpipe slots.

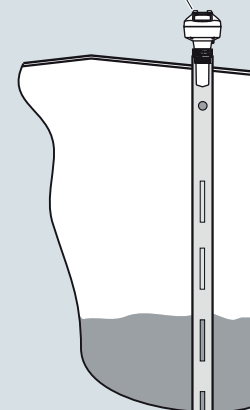

Mounting on vessel

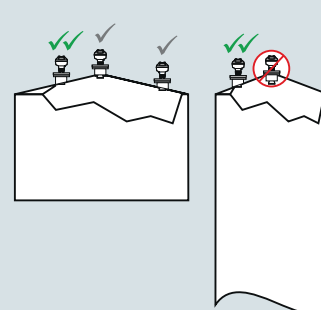

Mounting on a nozzle

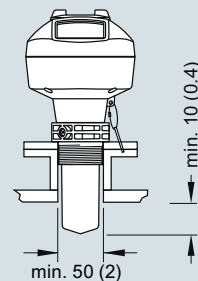

SITRANS LR250 PVDF Antenna installation, dimensions in mm (inch)









Technical specifications

Mode of operation		Certificates and approvals	
Measuring principle	Radar level measurement	General	CSA _{US/CA} , CE, FM, RCM
Frequency	K-band (25.0 GHz)	Radio	FCC, Industry Canada, RED, RCM
Minimum measuring range	50 mm (2 inch) from end of antenna	Hazardous	
Maximum measuring range	10 m (32.8 ft) or 20 m (66 ft) when used in a stilling pipe with dk ≥ 1.6	• Explosion Proof (Brazil)	INMETRO Ex d ia mb IIC T4 Ga/Gb, Ex ia ta IIC T100 °C Da
Output		• Increased Safety (Brazil)	INMETRO Ex e ia mb IIC T4 Ga/Gb, Ex ia ta IIC T100 °C Da
HART	Version 5.1	• Intrinsically Safe (Brazil)	INMETRO Ex ia IIC T4 Ga, Ex ia ta IIC T100 °C Da
• Analog output	4 ... 20 mA	• Explosion Proof (Canada/USA)	CSA/FM Class I, Div. 1, Groups A, B, C, D; Class II, Div. 1, Groups E, F, G; Class III T4
• Accuracy	± 0.02 mA	• Intrinsically Safe (Canada/USA)	CSA/FM Class I, Div. 1, Groups A, B, C, D; Class II, Div. 1, Groups E, F, G; Class III T4
• Fail-safe	• Programmable as high low or hold (loss of echo) • NE 43 programmable	• Non-incendive (Canada/USA)	CSA/FM Class I, Div. 2, Groups A, B, C, D T5
PROFIBUS PA	Profile 3.1	• Flame Proof/Increased Safety (China)	Ex d ia mb IIC T4 Ga/Gb, Ex e ia mb IIC T4 Ga/Gb, Ex iaD 20 T90 IP67 DIP A20 T _A 90 °C
• Function blocks	2 Analog Input (AI)	• Intrinsically Safe (China)	Ex ia IIC T4 Ga, Ex iaD 20 T90 IP67 DIP A20 T _A 90 °C
FOUNDATION Fieldbus	H1	• Non-sparking (China)	NEPSI Ex nA IIC T4 Gc
• Functionality	Basic or LAS	• Intrinsically Safe (Europe)	ATEX II 1G Ex ia IIC T4 Ga ATEX II 1D Ex ia ta IIC T100 °C Da ATEX II 3G Ex nA IIC T4 Gc
• Version	ITK 5.2.0	• Non-sparking/Energy Limited (Europe)	IECEX/ATEX II 1/2 GD, 1D, 2D, Ex d mb ia IIC T4 Ga/Gb, Ex ia ta IIC T100 °C Da
• Function blocks	2 Analog Input (AI)	• Flame Proof (International/Europe)	IECEX/ATEX II 1/2 GD, 1D, 2D, Ex e mb ia IIC T4 Ga/Gb, Ex ia ta IIC T100 °C Da
Performance (according to reference conditions IEC60770-1)		• Intrinsically Safe (International)	IECEX/ATEX II 1 G Ex ia IIC T4 Ga, IECEX/ATEX II 1D Ex ia ta IIC T100 °C Da
Maximum measured error	• > 500 mm from sensor reference point: 3 mm (0.118 inch) • < 500 mm from sensor reference point: 25 mm (1 inch)	• Explosion Proof (Russia/Kazakhstan)	EAC Ex d
Influence of ambient temperature	< 0.003 %/K	• Increased Safety (Russia/Kazakhstan)	EAC Ex e
Rated operating conditions		• Intrinsically Safe (Russia/Kazakhstan)	EAC Ex ia
Installation conditions		• Marine	• Lloyd's Register of Shipping • ABS Type Approval • Bureau Veritas
• Location	Indoor/outdoor	Functional Safety	SIL-2 suitable in accordance with IEC 61508/61511
Ambient conditions (enclosure)		Programming	
• Ambient temperature	-40 ... +80 °C (-40 ... +176 °F)	Intrinsically Safe Siemens handheld programmer	Infrared receiver
• Installation category	I	• Approvals for handheld programmer	IS model: ATEX II 1 GD Ex ia IIC T4 Ga Ex ia D 20 T135 °C T _A = -20 ... +50 °C CSA/FM Class I, II, III, Div. 1, Groups A, B, C, D, E, F, G, T6 T _A = +50 °C IECEX SIR 09.0073
• Pollution degree	4	Handheld communicator	HART communicator 375/475
Medium conditions		PC	• SIMATIC PDM • Emerson AMS • SITRANS DTM (for connection into FDT, such as PACTware or Fieldcare)
Dielectric constant ϵ_r	≥ 3 (1.6 in stillpipe)	Display (local)	Graphic local user interface including quick start wizard and echo profile displays
Process temperature	-40 ... +80 °C (-40 ... +176 °F) at process connection (Is suitable for CIP at 120 °C for 1/2 hr max.)		
Process pressure	Up to 5 bar g (72 psi g) temperature dependent. See Pressure/Temperature curves for more information		
Design			
Enclosure			
• Material	Aluminum, polyester powder-coated		
• Cable inlet	2 x M20 x 1.5 or 2 x 1/2" NPT		
Degree of protection	Type 4X/NEMA 4X, Type 6/NEMA 6, IP67, IP68		
Weight	Approximately 3.3 kg (7.27 lb)		
Display (local)	Graphic local user interface including quick start wizard and echo profile display		
Antenna			
• Material	PVDF (Polyvinylidene fluoride)		
• Dimensions (nominal sizes)	2 inch (48 mm)		
Process connections			
• Process connection	2" NPT [(Taper), ASME B1.20.1] 2" [(BSPT), EN 10226] 2" [(BSPP), EN ISO 228-1]		
Power supply			
4 ... 20 mA/HART	Nominal 24 V DC (max. 30 V DC) with max. 550 Ω		
PROFIBUS PA	• 15 mA • per IEC 61158-2		
FOUNDATION Fieldbus	• 20.0 mA • per IEC 61158-2		

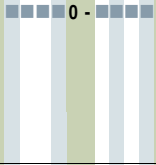
Level Measurement

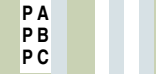
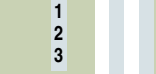
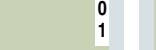
Continuous level measurement
Radar transmitters

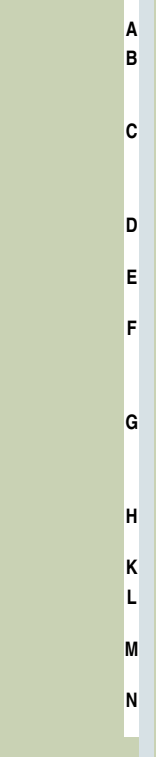
SITRANS LR250 Threaded PVDF Antenna

Selection and Ordering data	Article No.
SITRANS LR250 Threaded PVDF Antenna  7ML5431- 2-wire, 25 GHz pulse radar level transmitter for continuous monitoring of liquids and slurries in storage and process vessels including corrosives or aggressive materials, to a range of 10 m (32.8 ft) or 20 m (66 ft) when used in a stilling pipe.  Click on the Article No. for the online configuration in the PIA Life Cycle Portal.	
Process Connection and Antenna Material Threaded PVDF antenna	
Process Connection Type Threaded connections PVDF 2" NPT (ASME B1.20.1) (tapered thread) R 2" [(BSPT), EN 10226-1] (tapered thread) G 2" [(BSPP), EN ISO 228-1] (parallel thread)	
Communication/Output PROFIBUS PA 4 ... 20 mA, HART, start-up at < 3.6 mA FOUNDATION Fieldbus	
Enclosure/Cable inlet Aluminum, Epoxy painted 2 x 1/2" NPT 2 x M20 x 1.5	
Antenna 2 inch (50 mm) threaded PVDF antenna	
Approvals General Purpose, CE, CSA, FM, FCC, RED, RCM Intrinsically Safe: CSA/FM Class I, Div. 1, Groups A, B, C, D, Class II, Div. 1, Groups E, F, G, Class III T4 FCC, Industry Canada Intrinsically Safe: IECEx/ATEX II 1 G Ex ia IIC T4 Ga, IECEx/ATEX II 1D Ex ia ta IIIC T100 °C Da, INMETRO Ex ia IIC T4 Ga, Ex ia ta IIIC T100 °C Da, CE, RED, RCM Non-incendive: CSA/FM Class I, Div. 2, Groups A, B, C, D T5, FCC, Industry Canada Non Sparking: ATEX II 3G Ex nA IIC T4 Gc, CE, RED, RCM Increased Safety: IECEx/ATEX II 1/2 GD, 1D, 2D Ex e mb ia IIC T4 Ga/Gb, Ex ia ta IIIC T100 °C Da, INMETRO Ex e ia mb IIC T4 Ga/Gb, Ex ia ta IIIC T100 °C Da, CE, RED, RCM ¹⁾ Flameproof: IECEx/ATEX II 1/2 GD 1D, 2D Ex d mb ia IIC T4 Ga/Gb, Ex ia ta IIIC T100 °C Da, INMETRO Ex d ia mb IIC T4 Ga/Gb, Ex ia ta IIIC T100 °C Da, CE, RED, RCM ¹⁾ Explosion proof: CSA/FM Class I, II and III, Div. 1, Groups A, B, C, D, E, F, G, FCC, Industry Canada ¹⁾ Non Sparking: NEPSI Ex nA IIC T4 Gc Intrinsically Safe: NEPSI Ex ia IIC T4 Ga, Ex iaD 20 T90 IP67 DIP A20 T _A 90 °C Flameproof: NEPSI Ex d ia mb IIC T4 Ga/Gb, Ex iaD 20 T90 IP67 DIP A20 T _A 90 °C ¹⁾ Increased Safety: NEPSI Ex e ia mb IIC T4 Ga/Gb, Ex iaD 20 T90 IP67 DIP A20 T _A 90 °C ¹⁾	
Pressure rating Rating per Pressure/Temperature curves in manual	

¹⁾ Applicable to Communication option 2 only

Selection and Ordering data	Order code
Further designs Please add "-Z" to Article No. and specify Order code(s).	
Plug M12 with mating Connector ¹⁾²⁾³⁾	A50
Plug 7/8" with mating Connector ²⁾³⁾⁴⁾	A55
Stainless steel tag [69 x 50 mm (2.71 x 1.97 inch)]: Measuring-point number/identification (max. 27 characters); specify in plain text	Y15
Manufacturer's test certificate: M to DIN 55350, Part 18 and to ISO 9000	C11
Material inspection Certificate Type 3.1 per EN 10204	C12
Functional Safety (SIL 2). Device suitable for use in accordance with IEC 61508 and IEC 61511 ⁵⁾⁶⁾	C20
Namur NE43 compliant, device preset to failsafe < 3.6 mA ⁵⁾	N07
Compact Operating Instructions for HART/ mA device	Article No.
English, French, German, Spanish, Italian, Dutch, Danish, Finnish, Greek, Portuguese (Portugal), Swedish	A5E33469191
English, Bulgarian, Czech, Estonian, Hungarian, Latvian, Lithuanian, Polish, Romanian, Slovakian, Slovenian	A5E33469171
English, Portuguese (Brazil), Chinese	A5E34046583
Note: The Operating Instructions should be ordered as a separate line item on the order. All literature is available to download for free, in a range of languages, at http://www.siemens.com/processinstrumentation/documentation	
Compact Operating Instructions for PROFIBUS PA device	Article No.
English, French, German, Spanish, Italian, Dutch, Danish, Finnish, Greek, Portuguese (Portugal), Swedish	A5E33469239
English, Bulgarian, Czech, Estonian, Hungarian, Latvian, Lithuanian, Polish, Romanian, Slovakian, Slovenian	A5E33472685
English, Portuguese (Brazil), Chinese	A5E34046624
Note: The Operating Instructions should be ordered as a separate line item on the order. All literature is available to download for free, in a range of languages, at http://www.siemens.com/processinstrumentation/documentation	

Level Measurement
Continuous level measurement
Radar transmitters

SITRANS LR250 Threaded PVDF Antenna

Selection and Ordering data	Article No.	Selection and Ordering data	Article No.
<p>Compact Operating Instructions for FOUNDATION Fieldbus device</p> <p>English, French, German, Spanish, Italian, Dutch, Danish, Finnish, Greek, Portuguese (Portugal), Swedish</p> <p>English, Bulgarian, Czech, Estonian, Hungarian, Latvian, Lithuanian, Polish, Romanian, Slovakian, Slovenian</p> <p>English, Portuguese (Brazil), Chinese</p> <p>Note: The Operating Instructions should be ordered as a separate line item on the order.</p> <p>All literature is available to download for free, in a range of languages, at http://www.siemens.com/processinstrumentation/documentation</p>	<p>A5E33472700</p> <p>A5E33472738</p> <p>A5E34046626</p>	<p>Accessories</p> <p>Handheld programmer, Intrinsically safe, EEx ia HART modem/USB (for use with a PC and SIMATIC PDM)</p> <p>One metallic cable gland M20 x 1.5, rated -40 ... +80 °C (-40 ... +176 °F), HART</p> <p>One metallic cable gland M20 x 1.5, rated -40 ... +80 °C (-40 ... +176 °F), PROFIBUS PA and FOUNDATION Fieldbus²⁾</p> <p>FDA approved FKM o-ring for 2" G (BSPP) process connections -28 ... +80 °C (-28 ... +176 °F)</p> <p>SITRANS RD100, loop powered display - see Chapter 7</p> <p>SITRANS RD200, universal input display with Modbus conversion - see Chapter 7</p> <p>SITRANS RD300, dual line display with totalizer and linearization curve and Modbus conversion - see Chapter 7</p> <p>SITRANS RD500 web, universal remote monitoring solution for instrumentation - see Chapter 7</p> <p>For applicable back up point level switch - see point level measurement section</p> <p>1) Available with Enclosure option 1 only 2) To be used with Communication options 1 and 3 only. Connector has IP67 rating. 3) Available with Approval options A and B. Available with approval option C for use on intrinsically safe applications only. Not rated for dust Ex. 4) Available with Enclosure option 0 only 5) Available with communication option 2 only 6) Available with approval options A, B, C, D, E, K, and L only</p>	<p>7ML1930-1BK</p> <p>7MF4997-1DB</p> <p>7ML1930-1AP</p> <p>7ML1930-1AQ</p> <p>7ML1830-3AN</p> <p>7ML5741-...</p> <p>7ML5740-...</p> <p>7ML5744-...</p> <p>7ML5750-...</p>
<p>Other Operating Instructions</p> <p>SITRANS LR250 Functional Safety manual, English</p> <p>Note: The Operating Instructions should be ordered as a separate line item on the order.</p> <p>All literature is available to download for free, in a range of languages, at http://www.siemens.com/processinstrumentation/documentation</p>	<p>A5E32286471</p>		

Characteristic curves

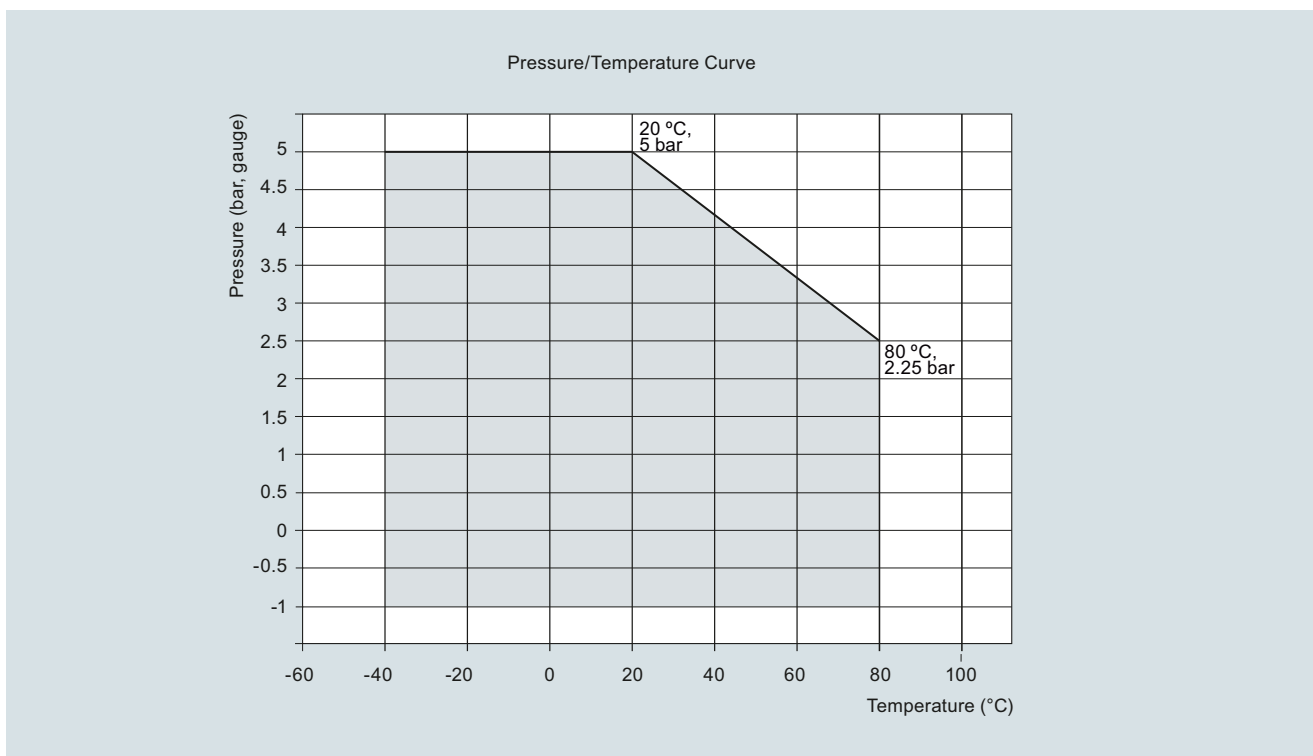

SITRANS LR250 PVDF Antenna pressure/temperature curve

Level Measurement

Continuous level measurement
Radar transmitters

SITRANS LR250 Threaded PVDF Antenna

Dimensional drawings

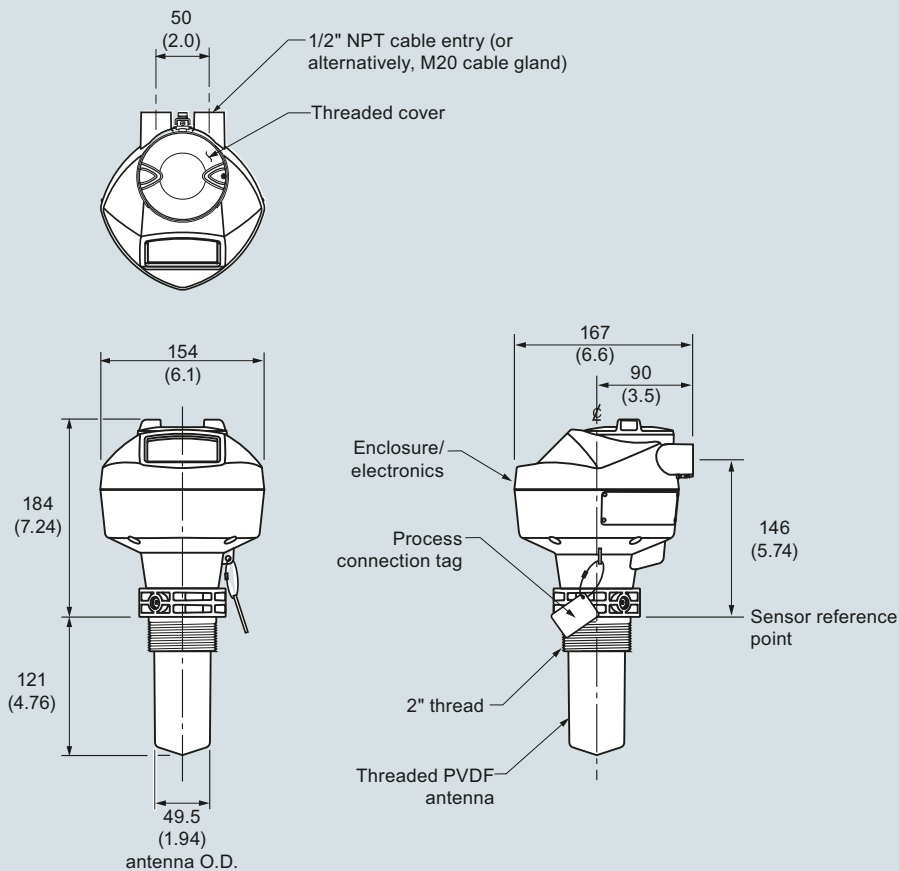

SITRANS LR250 PVDF Antenna, dimensions in mm (inch)

Circuit diagrams

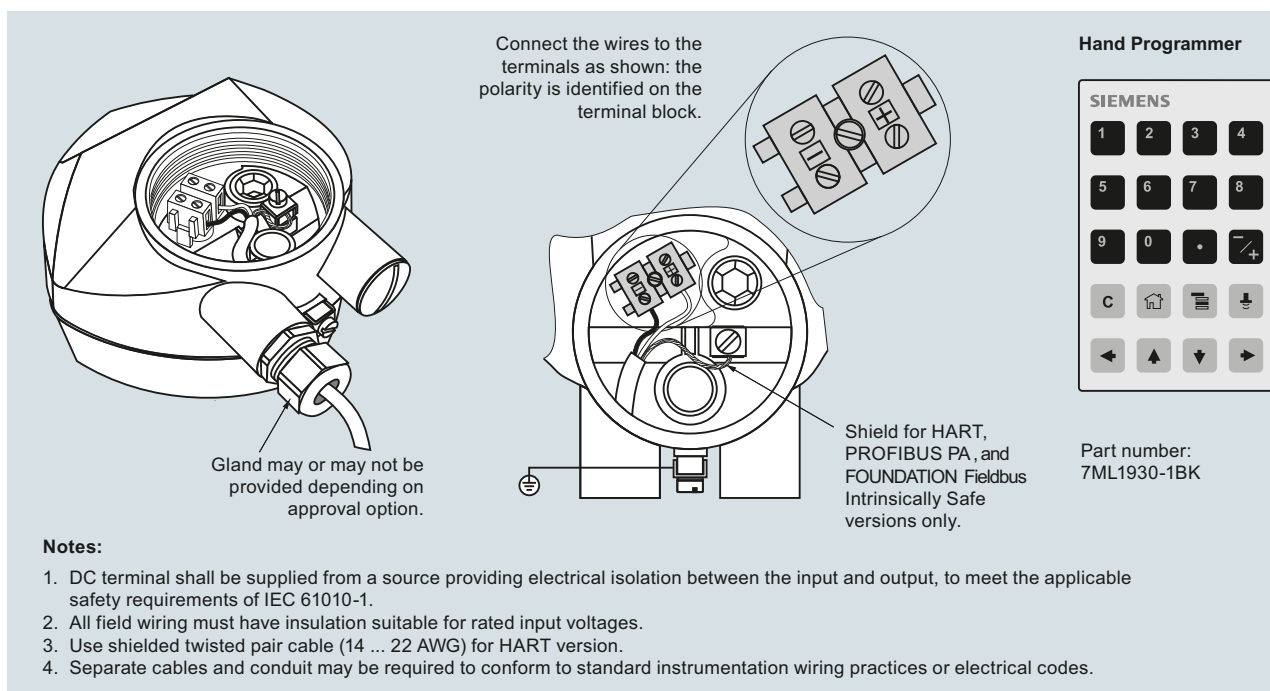

SITRANS LR250 connections

Selection and Ordering data

SITRANS LR250 threaded PVDF Specials		SITRANS LR250 threaded PVDF Specials	
	Article No.		Article No.
NOTE: LR260 head can be supplied with any LR250 process connection or antenna as special order. For LR250, this means a stronger signal and longer measurement range is possible.		SITRANS LR250 threaded PVDF antenna version enclosures (< 3.6 mA start-up HART models)	
SITRANS LR250 threaded PVDF antenna version enclosures (PROFIBUS PA models)		SITRANS LR250 enclosure with board stack, M20 cable inlet, approval option A, with HART communication start-up at < 3.6 mA, no process connection	A5E03569747
SITRANS LR250 threaded PVDF antenna version enclosure with board stack, M20 cable inlet, approval option A, with PROFIBUS PA communication, no process connection	A5E03588171	SITRANS LR250 enclosure with board stack, NPT cable inlet, approval option A, with HART communication start-up at < 3.6 mA, no process connection	A5E03586807
SITRANS LR250 threaded PVDF antenna version enclosure with board stack, NPT cable inlet, approval option A, with PROFIBUS PA communication, no process connection	A5E03588253	SITRANS LR250 enclosure with board stack, NPT cable inlet, approval option B, with HART communication start-up at < 3.6 mA, no process connection	A5E03586854
SITRANS LR250 threaded PVDF antenna version enclosure with board stack, NPT cable inlet, approval option B, with PROFIBUS PA communication, no process connection	A5E03588512	SITRANS LR250 enclosure with board stack, M20 cable inlet, approval option C, with HART communication start-up at < 3.6 mA, no process connection	A5E03586887
SITRANS LR250 threaded PVDF antenna version enclosure with board stack, M20 cable inlet, approval option C, with PROFIBUS PA communication, no process connection	A5E03589260	SITRANS LR250 enclosure with board stack, NPT cable inlet, approval option D, with HART communication start-up at < 3.6 mA, no process connection	A5E03586961
SITRANS LR250 threaded PVDF antenna version enclosure with board stack, NPT cable inlet, approval option D, with PROFIBUS PA communication, no process connection	A5E03589262	SITRANS LR250 enclosure with board stack, M20 cable inlet, approval option E, with HART communication start-up at < 3.6 mA, no process connection	A5E03587012
SITRANS LR250 threaded PVDF antenna version enclosure with board stack, M20 cable inlet, approval option E, with PROFIBUS PA communication, no process connection	A5E03589264	SITRANS LR250 enclosure with board stack, M20 cable inlet, approval option F, with HART communication start-up at < 3.6 mA, no process connection	A5E03587132
SITRANS LR250 threaded PVDF antenna version enclosures (FOUNDATION Fieldbus models)		SITRANS LR250 enclosure with board stack, M20 cable inlet, approval option G, with HART communication start-up at < 3.6 mA, no process connection	A5E03587223
SITRANS LR250 enclosure with board stack, M20 cable inlet, approval option A, with FOUNDATION Fieldbus communication, no process connection	A5E03589266	SITRANS LR250 enclosure with board stack, NPT cable inlet, approval option H, with HART communication start-up at < 3.6 mA, no process connection	A5E03588125
SITRANS LR250 enclosure with board stack, NPT cable inlet, approval option A, with FOUNDATION Fieldbus communication, no process connection	A5E03589275	SITRANS LR250 threaded PVDF antenna kits	
SITRANS LR250 enclosure with board stack, NPT cable inlet, approval option B, with FOUNDATION Fieldbus communication, no process connection	A5E03589277	Antenna kit 2" NPT threaded PVDF	A5E03528941
SITRANS LR250 enclosure with board stack, M20 cable inlet, approval option C, with FOUNDATION Fieldbus communication, no process connection	A5E03589280	Antenna kit 2" R (BSPT) threaded PVDF	A5E03528943
SITRANS LR250 enclosure with board stack, NPT cable inlet, approval option D, with FOUNDATION Fieldbus communication, no process connection	A5E03589281	Antenna kit 2" G (BSPP) threaded PVDF	A5E03528947
SITRANS LR250 enclosure with board stack, M20 cable inlet, approval option E, with FOUNDATION Fieldbus communication, no process connection	A5E03589283	Kit of hardware parts for LR250 threaded PVDF antenna: consists of O-rings, screws, wavewasher, and loctite	A5E03528948
		Ex-proof plugs	
		Ex-proof plugs kit, 1/2" NPT, qty 5	A5E39979991
		Ex-proof plugs kit, M20, qty 5	A5E39979992