

### Overview

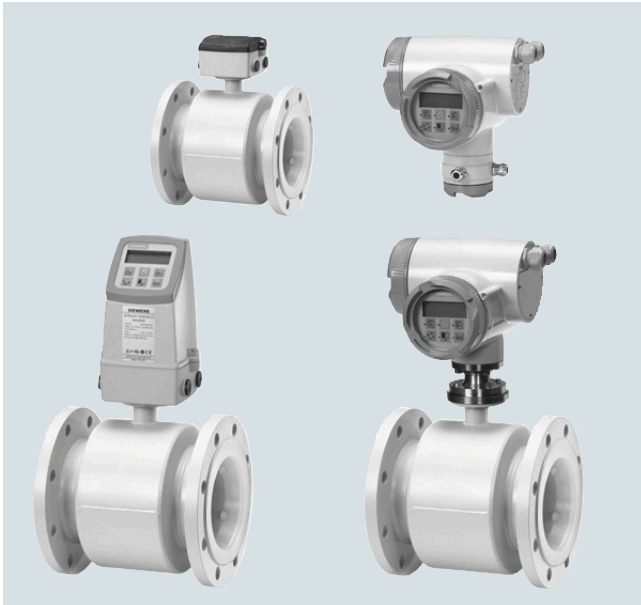

The SITRANS F M MAG 3100 P is designed to meet the most common specifications within chemical and process industries.

### Benefits

- DN 15 to DN 300 (½" to 12")
- Included in Quick Ship Program (delivery time see PIA LCP)
- Most used flowmeter in the chemical and process industries with PTFE/PFA liner and Hastelloy electrodes
- Excellent chemical resistance
- Full scope of global approvals for hazardous areas:
  - ATEX, FM, CSA, IECEx
  - 24 V and 115/230 V Ex compact and remote
  - intrinsically safe ia analog output
- Comprehensive self-diagnostic for error indication and error logging
- Fully welded construction provides a ruggedness that suits the toughest applications and environments
- Easy commissioning, the SENSORPROM unit automatically updates settings.
- MAG 6000 I full NAMUR compliance
  - compliant with NE 21, NE 32, NE 43, NE 53 and NE 70

### Application

The main applications of the SITRANS F M electromagnetic flow sensors can be found in the following fields:

- Chemical industry
- Process industry
- Pulp and paper
- Industrial waste water

### Design

- Compact or remote mounting possible
- Easy "plug & play" field changeability of transmitter
- High temperature sensor for applications with temperatures up to 150 °C (302 °F)
- Meets EEC directives: PED, 2014/68/EU pressure directive for EN1092-1 flanges
- Built-in length according to ISO 13359
- Onsite or factory upgrade to IP68/NEMA 6P of a standard sensor.

### Mode of operation

The flow measuring principle is based on Faraday's law of electromagnetic induction according to which the sensor converts the flow into an electrical voltage proportional to the velocity of the flow.

### Integration

The complete flowmeter consists of a flow sensor and an associated transmitter MAG 5000, 6000 and 6000 I.

The flexible communication concept USM II simplifies integration and update to a variety of fieldbus systems such as HART, FOUNDATION Fieldbus H1, DeviceNet, PROFIBUS DP and PA, Modbus RTU/RS 485.

### Pressure/temperature curve to EN (DIN) flanges, material A 105 carbon steel

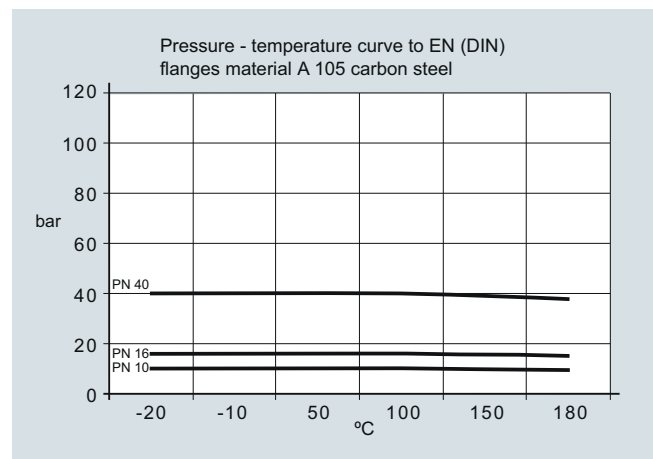

### Pressure/temperature curve to ANSI B16.5 flanges

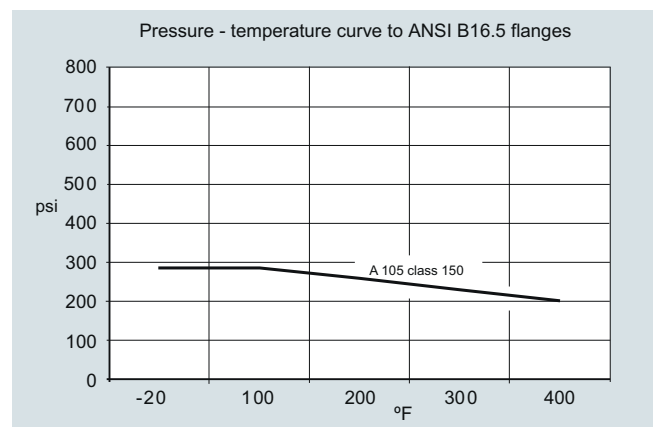

**Note:** The pressure-temperature curves only assist in the selection of a system. No responsibility is taken for the correctness of the information. For further information on the PED standard and requirements, see page 10/15.

# Flow Measurement

## SITRANS F M

### Flow sensor MAG 3100 P

#### Technical specifications

<b>Product characteristic</b>	Chemical and process industry-oriented (Included in Quick Ship Program)
Nominal size	<ul style="list-style-type: none"> <li>• PTFE: DN 15 ... 300 (½" ... 12")</li> <li>• PFA: DN 15 ... 150 (½" ... 6")</li> </ul>
Measuring principle	Electromagnetic induction
Excitation frequency (Mains supply: 50 Hz/60 Hz)	<ul style="list-style-type: none"> <li>• DN 15 ... 65 (½" ... 2½"): 12.5 Hz/15 Hz</li> <li>• DN 80 ... 150 (3" ... 6"): 6.25 Hz/7.5 Hz</li> <li>• DN 200 ... 300 (8" ... 12"): 3.125 Hz/3.75 Hz</li> </ul>
<b>Process connection</b>	
Flanges	EN 1092-1, raised face <sup>1)</sup> (EN 1092-1, DIN 2501 and BS 4504 have the same mating dimensions) <ul style="list-style-type: none"> <li>• DN 15 ... 50 (½" ... 2"): PN 40 (580 psi)</li> <li>• DN 65 ... 300 (2½" ... 12"): PN 16 (232 psi)</li> <li>• DN 200 ... 300 (8" ... 12"): PN 10 (145 psi)</li> </ul> ANSI B16.5 (~BS 1560), raised face <ul style="list-style-type: none"> <li>• ½" ... 12": Class 150 (20 bar (290 psi))</li> </ul>
<b>Rated operation conditions</b>	
Ambient temperature (conditions also dependent on liner characteristics)	
<ul style="list-style-type: none"> <li>• Standard sensor</li> </ul>	-40 ... +100 °C (-40 ... +212 °F)
<ul style="list-style-type: none"> <li>• Ex sensor</li> </ul>	-20 ... +60 °C (-4 ... +140 °F)
<ul style="list-style-type: none"> <li>• Compact with transmitter</li> </ul>	
- MAG 5000/6000	-20 ... +60 °C (-4 ... +140 °F)
- MAG 6000 I	-20 ... +60 °C (-4 ... +140 °F)
- MAG 6000 I Ex	-20 ... +60 °C (-4 ... +140 °F)
<b>Operating pressure</b> [abs. bar] (maximum operating pressure decreases with increasing operating temperature and with stainless steel flanges)	<ul style="list-style-type: none"> <li>• PTFE Teflon               <ul style="list-style-type: none"> <li>- DN 15 ... 300 (½" ... 12"): 0.3 ... 40 bar (4 ... 580 psi)</li> </ul> </li> <li>• PFA               <ul style="list-style-type: none"> <li>- DN 15 ... 150 (½" ... 6"): Vacuum 0.02 ... 50 bar (0.29 ... 725 psi)</li> </ul> </li> </ul>
Enclosure rating	IP67 to EN 60529/NEMA 4X/6, 1 mH <sub>2</sub> O for 30 min Option: IP68 to EN 60529/NEMA 6P, 10 mH <sub>2</sub> O cont. (not for Ex)
Pressure drop at 3 m/s	As straight pipe
Test pressure	1.5 x PN (where applicable)
Mechanical load (vibration)	<ul style="list-style-type: none"> <li>• 18 ... 1000 Hz random in x, y, z, directions for 2 hours according to EN 60068-2-36</li> <li>• Sensor: 3.17 g RMS</li> <li>• Sensor with compact MAG 5000/6000 mounted transmitter: 3.17 g RMS</li> <li>• Sensor with compact MAG 6000 I/6000 I Ex mounted transmitter: 1.14 g RMS</li> </ul>
Temperature of medium	<ul style="list-style-type: none"> <li>• PTFE -20 ... +150 °C (-4 ... +302 °F)</li> <li>• PFA -20 ... +150 °C (-4 ... +302 °F)</li> </ul>
EMC	2014/30/EU

<b>Design</b>	
Weight	See dimensional drawings
Flange and housing material	Carbon steel ASTM A 105, with corrosion resistant coating Corrosivity category C4, according to ISO 12944-2
Electrode material	PTFE: Hastelloy C276/2.4819 PFA: Hastelloy C22/2.4602
Grounding electrode material	PTFE: No grounding electrodes PFA: Hastelloy
Terminal box (remote version only)	<ul style="list-style-type: none"> <li>• Standard fibre glass reinforced polyamide</li> <li>• Option Stainless steel AISI 316/1.4436</li> <li>• Ex sensor: Stainless steel AISI 316/1.4436</li> </ul>
Cable entries	<ul style="list-style-type: none"> <li>• Remote installation 2 x M20 or 2 x ½" NPT</li> <li>• Compact installation               <ul style="list-style-type: none"> <li>- MAG 5000/MAG 6000: 4 x M20 or 4 x ½" NPT</li> <li>- MAG 6000 I: 2 x M25 or 2 x ½" NPT (for supply/output)</li> <li>- MAG 6000 I Ex: 2 x M25 or 2 x ½" NPT (for supply/output)</li> </ul> </li> </ul>
<b>Certificates and approvals</b>	
Calibration	
Standard production calibration	Zero-point, 2 x 25 % and 2 x 90 %
Hazardous area	
Ex-sensor in compact or remote version with MAG 6000 I Ex	<ul style="list-style-type: none"> <li>• ATEX, FM, CSA, IECEx, EAC Ex, NEPSI               <ul style="list-style-type: none"> <li>- Zone 1 Ex de ia IIC T6 Gb</li> </ul> </li> <li>• ATEX, FM, CSA, IECEx, EAC Ex               <ul style="list-style-type: none"> <li>- Zone 21 Ex tD A21 IP67</li> </ul> </li> <li>• FM               <ul style="list-style-type: none"> <li>- XP IS Class I Div. 1 Groups A, B, C, D<sup>2)</sup></li> <li>- DIP Class II+III Div. 1 Groups E, F, G<sup>2)</sup></li> </ul> </li> <li>• FM               <ul style="list-style-type: none"> <li>- NI Class I Div. 2 Groups A, B, C, D</li> <li>- NI Class I Div. 2 Groups IIC</li> </ul> </li> </ul>
Ex-sensor with/without MAG 5000/6000/6000 I	
Pressure equipment	PED, CRN
Others	EAC (Russia, Belarus, Kazakhstan) KCC (South Korea)

<sup>1)</sup> DN ≤ 600 type 01 (SORF); DN > 600 type 11 (WNRFF)

<sup>2)</sup> In compact version only

Selection and Ordering data	Article No.
<b>Sensor SITRANS F M MAG 3100 P (Short delivery time)</b>	7ME6340-
Click on the Article No. for the online configuration in the PIA Life Cycle Portal.	
<b>Diameter</b>	
DN 15 (1/2")	1 V
DN 25 (1")	2 D
DN 40 (1 1/2")	2 R
DN 50 (2")	2 Y
DN 65 (2 1/2")	3 F
DN 80 (3")	3 M
DN 100 (4")	3 T
DN 125 (5")	4 B
DN 150 (6")	4 H
DN 200 (8")	4 P
DN 250 (10")	4 V
DN 300 (12")	5 D
<b>Flange norm and pressure rating</b>	
EN 1092-1	
PN 10 (DN 200 ... 300 (8" ... 12"))	B
PN 16 (DN 65 ... 300 (2 1/2" ... 12"))	C
PN 40 (DN 15 ... 50 (1/2" ... 2"))	F
ANSI B16.5	
Class 150 (1/2" ... 12")	J
<b>Flange material</b>	
Carbon steel flanges ASTM A 105	1
<b>Liner material</b>	
PTFE (150 °C (302 °F))	3
PFA (150 °C (302 °F)) (DN 15 ... 150 (1/2" ... 6"))	7
<b>Electrode material</b>	
Hastelloy C	2
Hastelloy C incl. grounding electrodes (only PFA)	6
<b>Transmitter</b>	
Standard sensor for remote transmitter (Order transmitter separately)	A
Ex sensor for remote transmitter (Order transmitter separately)	B
MAG 6000 I, Aluminum, 18 ... 90 V DC, 115 ... 230 V AC	C
MAG 6000 I, Aluminum, 18 ... 30 V DC, Ex	D
MAG 6000 I, Aluminum, 115 ... 230 V AC, Ex	E
MAG 6000, Polyamide, 11 ... 30 V DC/11 ... 24 V AC	H
MAG 6000, Polyamide, 115 ... 230 V AC	J
MAG 5000, Polyamide, 11 ... 30 V DC/11 ... 24 V AC	K
MAG 5000, Polyamide, 115 ... 230 V AC	L
<b>Communication</b>	
No communication, add-on possible	A
HART	B
PROFIBUS PA Profile 3 (only MAG 6000/MAG 6000 I)	F
PROFIBUS DP Profile 3 (not for Ex) (only MAG 6000/MAG 6000 I)	G
Modbus RTU/RS 485 (not for Ex) (only MAG 6000/MAG 6000 I)	E
FOUNDATION Fieldbus H1 (only MAG 6000/6000 I)	J
<b>Cable glands/terminal box</b>	
Metric: Polyamide terminal box or MAG 6000 I compact	1
1/2" NPT: Polyamide terminal box or MAG 6000 I compact	2
Metric: Stainless steel terminal box	3
1/2" NPT: Stainless steel terminal box	4

Selection and Ordering data	Order code
<b>Additional information</b>	
Please add "-Z" to Article No. and specify Order code(s) and plain text.	
<b>Certificates</b>	
• Factory certificate according to EN 10204-2.2	<b>C14</b>
• Factory certificate according to EN 10204-2.1	<b>C15</b>
<b>Terminal blocks</b>	
• Factory mounted terminal blocks	<b>N02</b>
<b>Region/customer specific labels</b>	
• KCC label (South Korea)	<b>W28</b>
Tag name plate, stainless steel (specify in plain text)	<b>Y17</b>
Tag name plate, plastic (self adhesive)	<b>Y18</b>
Customer-specific transmitter setting	<b>Y20</b>
Sensor cable wired (specify Article No. for sensor cables and order cables separately)	<b>Y40</b>
Sensor cables wired and IP68 sealing (Article No. for sensor cables and order cables separately)	<b>Y41</b>
Special version (specify in plain text)	<b>Y99</b>
<b>Additional calibrations</b>	
• Matched pair - (Standard production calibration where sensor and transmitter is calibrated together)	<b>On request<sup>1)</sup></b>
• Accredited Siemens Flow Instruments matched pair Calibration acc. to ISO/IEC 17025: 2005	<b>On request<sup>1)</sup></b>
• Customer-specified calibration up to 10 points	<b>On request<sup>1)</sup></b>
• Customer-witnessed calibration Any of above calibration	<b>On request<sup>1)</sup></b>

<sup>1)</sup> Product Variation Request (PVR).

**Operating instructions for SITRANS F M MAG 3100 P**

Description	Article No.
• English	<b>A5E03005599</b>
• German	<b>A5E03086288</b>

All literature is available to download for free, in a range of languages, at [www.siemens.com/processinstrumentation/documentation](http://www.siemens.com/processinstrumentation/documentation)

**Accessories**

Description	Article No.
Potting kit for IP68/NEMA 6P sealing of sensor junction box	<b>FDK:085U0220</b>



Please use online Product selector to get latest updates.  
Product selector link: [www.pia-portal.automation.siemens.com](http://www.pia-portal.automation.siemens.com)

## Flow Measurement

### SITRANS F M

#### Flow sensor MAG 3100 P

##### Accessories for MAG 3100 P sensor

##### Grounding and protection ring - Type E (Stainless steel)

Material: AISI 316  
For liner PTFE  
1 pc. incl. straps and screws

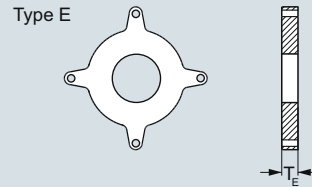

DN	PN 10 Article No.	PN 16 Article No.	PN 40 Article No.	ANSI <sup>1)</sup>	Class 150 Article No.
DN 15			<b>FDK:083N8365</b>	½"	<b>FDK:083N8365</b>
DN 25			<b>FDK:083N8271</b>	1"	<b>FDK:083N8272</b>
DN 40			<b>FDK:083N8278</b>	1½"	<b>FDK:083N8279</b>
DN 50		<b>FDK:083N8285</b> <b>FDK:083N8289</b>	<b>FDK:083N8282</b>	2"	<b>FDK:083N8283</b>
DN 65				2½"	<b>FDK:083N8287</b>
DN 80				3"	<b>FDK:083N8291</b>
DN 100		<b>FDK:083N8117</b> <b>FDK:083N8121</b> <b>FDK:083N8125</b>		4"	<b>FDK:083N8118</b>
DN 125				5"	<b>FDK:083N8122</b>
DN 150				6"	<b>FDK:083N8126</b>
DN 200	<b>FDK:083N8130</b>	<b>FDK:083N8130</b>		8"	<b>FDK:083N8370</b>
DN 250	<b>FDK:083N8136</b>	<b>FDK:083N8137</b>		10"	<b>FDK:083N8140</b>
DN 300	<b>FDK:083N8144</b>	<b>FDK:083N8145</b>		12"	<b>FDK:083N8148</b>

For use as protection ring order 2 pcs.  
For use as grounding ring order 1 pc.

##### Accessories for MAG 3100 P sensor

##### Grounding and protection ring - Type E (Hastelloy)

Material: Hastelloy C276  
For liner PTFE  
1 pc. incl. straps and screws

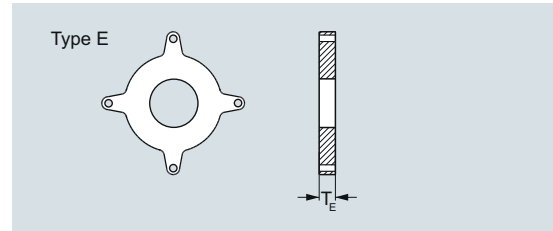

DN	PN 16 Article No.	PN 40 Article No.	Size	ANSI <sup>1)</sup> Class 150 Article No.
DN 15		<b>FDK:083N8487</b>	½"	<b>FDK:083N8487</b>
DN 25		<b>FDK:083N8488</b>	1"	<b>FDK:083N8489</b>
DN 40		<b>FDK:083N8490</b>	1½"	<b>FDK:083N8491</b>
DN 50		<b>FDK:083N8492</b>	2"	<b>FDK:083N8493</b>
DN 65	<b>FDK:083N8495</b>		2½"	<b>FDK:083N8497</b>
DN 80	<b>FDK:083N8499</b>		3"	<b>FDK:083N8501</b>
DN 100	<b>FDK:083N8504</b>		4"	<b>FDK:083N8506</b>

<sup>1)</sup> For dimensions of MAG 3100 P see table on page 3/88

**Accessories for MAG 3100 P sensor****Grounding ring - Type Flat ring (Stainless steel)**

Material: AISI 316  
For liner PTFE and PFA  
1 pc. incl. straps and screws

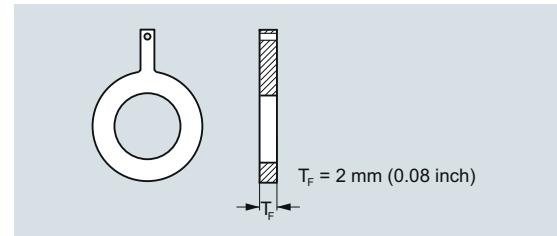

DN	PN 10 Article No.	PN 16 Article No.	PN 40 Article No.	Size	ANSI <sup>1)</sup> Class 150 Article No.
DN 15			<b>A5E01191968</b>	1/2"	<b>A5E01191969</b>
DN 25			<b>A5E01150880</b>	1"	<b>A5E01150022</b>
DN 40			<b>A5E01191952</b>	1 1/2"	<b>A5E01191961</b>
DN 50			<b>A5E01150918</b>	2"	<b>A5E01151121</b>
DN 65		<b>A5E01191940</b>		2 1/2"	<b>A5E01191962</b>
DN 80		<b>A5E01152876</b>		3"	<b>A5E01152910</b>
DN 100		<b>A5E01158875</b>		4"	<b>A5E01159146</b>
DN 125		<b>A5E01191941</b>		5"	<b>A5E01191963</b>
DN 150		<b>A5E01191943</b>		6"	<b>A5E01191964</b>
DN 200	<b>A5E01191951</b>	<b>A5E01191944</b>		8"	<b>A5E01191965</b>
DN 250	<b>A5E01191950</b>	<b>A5E01191946</b>		10"	<b>A5E01191966</b>
DN 300	<b>A5E01191949</b>	<b>A5E01191947</b>		12"	<b>A5E01191967</b>

**Accessories for MAG 3100 P sensor****Grounding ring - Type Flat ring (Hastelloy)**

Material: Hastelloy C276  
For liner PTFE and PFA  
1 pc. incl. straps and screws

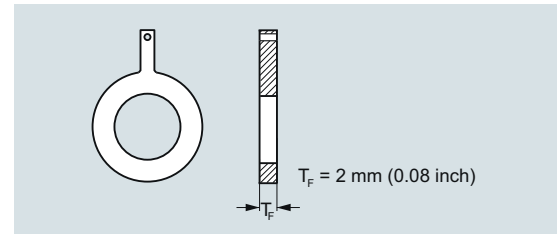

DN	PN 10 Article No.	PN 16 Article No.	PN 40 Article No.	Size	ANSI <sup>1)</sup> Class 150 Article No.
DN 15			<b>A5E01191981</b>	1/2"	<b>A5E01191989</b>
DN 25			<b>A5E01150882</b>	1"	<b>A5E01150028</b>
DN 40			<b>A5E01191982</b>	1 1/2"	<b>A5E01191990</b>
DN 50			<b>A5E01150922</b>	2"	<b>A5E01151124</b>
DN 65		<b>A5E01191971</b>		2 1/2"	<b>A5E01191991</b>
DN 80		<b>A5E01152889</b>		3"	<b>A5E01152913</b>
DN 100		<b>A5E01158886</b>		4"	<b>A5E01159150</b>
DN 125		<b>A5E01191973</b>		5"	<b>A5E01191992</b>
DN 150		<b>A5E01191974</b>		6"	<b>A5E01191993</b>
DN 200	<b>A5E01191978</b>	<b>A5E01191975</b>		8"	<b>A5E01191994</b>
DN 250	<b>A5E01191979</b>	<b>A5E01191976</b>		10"	<b>A5E01191995</b>
DN 300	<b>A5E01191980</b>	<b>A5E01191977</b>		12"	<b>A5E01191996</b>

<sup>1)</sup> For dimensions of MAG 3100 P see table on page 3/88

## Flow Measurement

### SITRANS F M

#### Flow sensor MAG 3100 P

#### Dimensional drawings

#### MAG 3100 P sensor with compact or remote transmitter

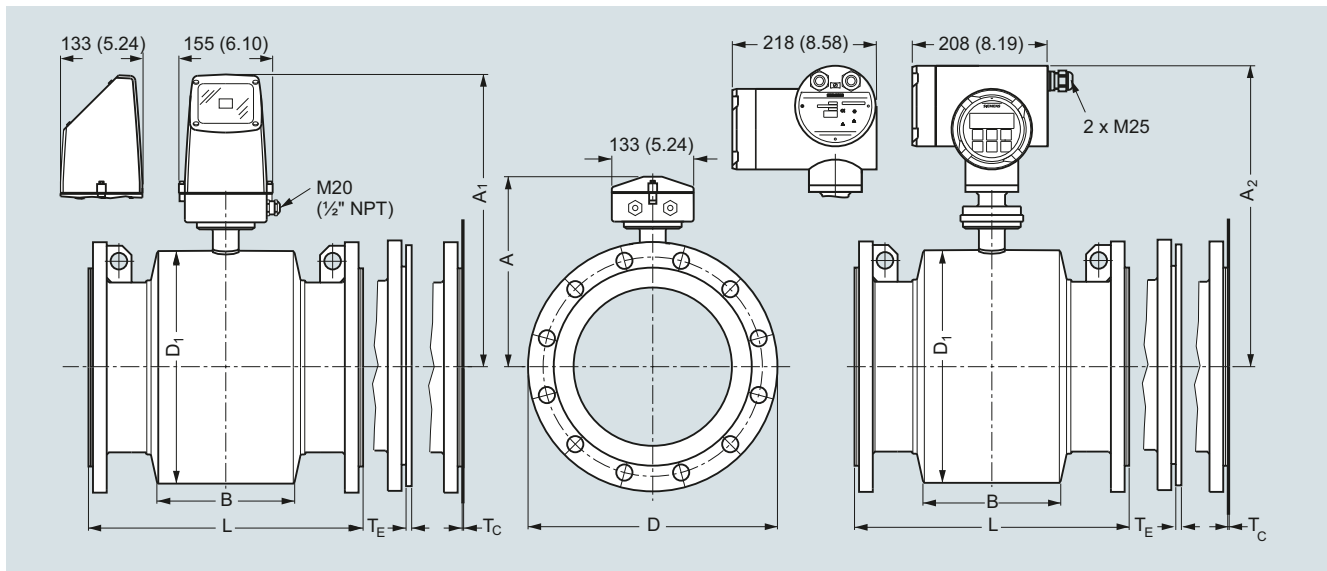

Dimensions in mm (inch)

Metric

DN	A <sup>1)</sup>	A <sub>1</sub>	A <sub>2</sub>	B	D <sub>1</sub>	L <sup>2)</sup>				T <sub>E</sub> <sup>3)</sup>	T <sub>F</sub> <sup>3)</sup>	Weight <sup>4)</sup>
						EN 1092-1-201 PN 10 [mm]	PN 16 [mm]	PN 40 [mm]	ANSI 16.5 Class 150 [mm]			
15	187	341	338	59	104	-	-	200	200	6	2	4
25	187	341	338	59	104	-	-	200	200	6	2	5
40	197	351	348	82	124	-	-	200	200	6	2	8
50	205	359	356	72	139	-	-	200	200	6	2	9
65	212	369	366	72	154	-	200/-	-	200	6	2	11
80	222	376	373	72	174	-	200/-	-	272 <sup>5)</sup>	6	2	12
100	242	396	393	85	214	-	250/-	-	250	6	2	16
125	255	409	406	85	239	-	250/-	-	250	6	2	19
150	276	430	427	85	282	-	300/-	-	300	6	2	27
200	304	458	455	137	338	350	350/-	-	350	8	2	40
250	332	486	483	157	393	450	450/-	-	450	8	2	60
300	357	511	508	157	444	500	500/-	-	500	8	2	80

<sup>1)</sup> 14.5 mm shorter with stainless steel terminal box (Ex and high temperature version)

<sup>2)</sup> When grounding rings are used, the thickness of the grounding ring must be added to the built-in length

<sup>3)</sup> T<sub>E</sub> = Grounding ring Type E, T<sub>F</sub> = Grounding ring Type Flat ring

<sup>4)</sup> Weights are approx. (for PN 16) without transmitter

<sup>5)</sup> Not according to ISO 13359

D = Outside diameter of flange, see flange tables

## MAG 3100 P sensor with compact or remote transmitter

## Imperial

Size	A <sup>1)</sup>	A <sub>1</sub>	A <sub>2</sub>	B	D <sub>1</sub>	L <sup>2)</sup>				T <sub>E</sub> <sup>3)</sup>	T <sub>F</sub> <sup>3)</sup>	Weight <sup>4)</sup>
						EN 1092-1-201 PN 10	PN 16	PN 40	ANSI 16.5 Class 150			
[inch]	[inch]	[inch]	[inch]	[inch]	[inch]	[inch]	[inch]	[inch]	[inch]	[inch]	[inch]	[lb]
½	7.36	13.4	13.34	2.32	4.09	-	-	7.87	7.87	0.24	0.08	9
1	7.36	13.4	13.34	2.32	4.09	-	-	7.87	7.87	0.24	0.08	11
1½	7.76	13.8	13.74	3.23	4.88	-	-	7.87	7.87	0.24	0.08	17
2	8.07	14.1	14.04	2.83	5.47	-	-	7.87	7.87	0.24	0.08	20
2½	8.35	14.4	14.34	2.83	6.06	-	7.87/-	-	7.87	0.24	0.08	24
3	8.74	14.8	14.74	2.83	6.85	-	7.87/-	-	10.71 <sup>5)</sup>	0.24	0.08	26
4	9.53	15.6	15.54	3.35	8.43	-	9.84/-	-	9.84	0.24	0.08	35
5	10.04	16.1	16.04	3.35	9.41	-	9.84/-	-	9.84	0.24	0.08	42
6	10.87	16.9	16.84	3.35	11.10	-	11.81/-	-	11.81	0.24	0.08	60
8	11.97	18.0	17.94	5.39	13.31	13.78	13.78/-	-	13.78	0.31	0.08	88
10	13.07	19.1	19.04	6.18	15.47	17.72	17.72/-	-	17.72	0.31	0.08	132
12	14.05	20.1	20.04	6.18	17.48	19.69	19.69/-	-	19.69	0.31	0.08	176

<sup>1)</sup> 0.571 inch shorter with stainless steel terminal box (Ex and high temperature version)

<sup>2)</sup> When grounding rings are used, the thickness of the grounding ring must be added to the built-in length

<sup>3)</sup> T<sub>E</sub> = Grounding ring Type E, T<sub>F</sub> = Grounding ring Type Flat ring

<sup>4)</sup> Weights are for ANSI 150 without transmitter

<sup>5)</sup> Not according to ISO 13359

D = Outside diameter of flange, see flange tables