

Temperature Measurement

Transmitters for rail mounting

SITRANS TR420, two-wire system, HART

Overview



- 2-wire temperature transmitter with HART communication interface
- Device for rail mounting
- Universal input for virtually any type of temperature sensor
- Connection of two independent input circuits for redundant operation (high input availability)
- Input drift detection
- Configurable over HART

Benefits

- Compact design
- Connection of two independent input circuits for redundant operation (high input availability)
- Electrical isolation
- Test terminals for ammeter
- Diagnostics LED (green/red)
- Input monitoring
Wire break and short-circuit
- Self-monitoring
- Configuration status stored in EEPROM
- Expanded diagnostic functions, such as slave pointer, operating hours counter, etc.
- Special characteristic
- Electromagnetic compatibility according to DIN EN 61326 and NE21
- SIL2/3 (with order note C20)

Application

SITRANS TR420 transmitters with two inputs can be used in all sectors. Their compact design enables simple mounting on standard DIN rails on-site in protective boxes or in control cabinets. The following sensors/signal sources can be connected over their universal input module:

- 2 resistance thermometers (2-wire, 3-wire, 4-wire connection)
- 2 thermocouples
- 2 linear resistors, potentiometer and DC voltage sources

The output signal is a load-independent direct current from 4 to 20 mA in accordance with the input characteristic, superimposed by the digital HART signal.

The dual input mode also supports drift detection of the inputs, whereby maintenance intervals can be more easily planned.

Transmitters of the "intrinsically safe or Zone 2 increased safety" type of protection can be installed in hazardous areas. The device meets the requirements of the EU Directive 2014/34/EU (ATEX), the FM and CSA regulations as well as other national approvals.

Function

The SITRANS TR420 is configured via HART. The configuration can be carried out using a handheld communicator or, more conveniently, with a HART modem and the SIMATIC PDM configuration software. The configuration data is then permanently stored in the non-volatile memory (EEPROM).

After correct connection of input and supply voltage, the transmitter outputs a temperature-linear output signal and the diagnostics LED is green. In case of external errors, e.g. sensor short circuit or interruption, the LED flashes red; an internal error is indicated by a permanent red light.

An ammeter can be connected at any time for checking and plausibility via the test terminals. The output current can be read without any interruption, or even without opening the current loop.

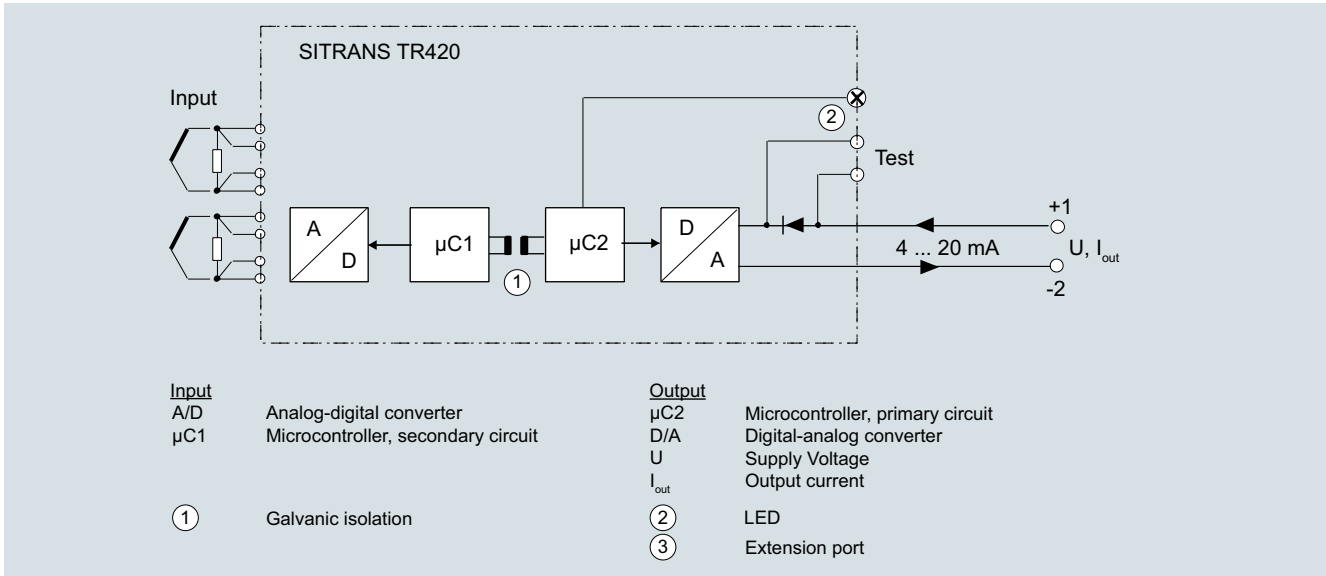

SITRANS TR420, function block diagram

Temperature Measurement

Transmitters for rail mounting

SITRANS TR420, two-wire system, HART

Technical specifications

General

Supply voltage ^{1) 2)}	
• Without explosion protection (non-Ex)	7.5 ... 48 V DC
• with explosion protection (Ex i)	7.5 ... 30 V DC
Additional minimum supply voltage when using test terminals	0.8 V
Maximum power loss	≤ 850 mW
Minimum load resistance at supply voltage > 37 V	$(V_{\text{supply}} - 37 \text{ V})/23 \text{ mA}$
Insulation voltage, test/operation	
• Without explosion protection (non-Ex)	2.5 kV AC/55 V AC
• with explosion protection (Ex i)	2.5 kV AC/42 V AC
Polarity protection	All inputs and outputs
Write protection	Open circuits or software
Warming-up time	< 5 min
Starting time	< 2.75 s
Programming	SIPROM T and HART
Signal-to-noise ratio	> 60 dB
Long-term stability	Better than: <ul style="list-style-type: none"> ± 0.05% of measuring span/year ± 0.18% of measuring span/5 years
Response time	≤ 75 ms (typically 70 ms)
Programmable damping	0 ... 60 s
Signal dynamic	
• Input	24 bit
• Output	18 bit
Influence of change in supply voltage	< 0.005% of measuring span/V DC

Input

Resistance thermometer (RTD)

Input type	
• Pt10 ... 10000	<ul style="list-style-type: none"> IEC 60751 JIS C 1604-8 GOST 6651_2009 Callendar-Van Dusen
• Ni10 ... 10000	<ul style="list-style-type: none"> DIN 43760-1987 GOST 6651-2009 / OIML R84:2003
• Cu5 ... 1000	<ul style="list-style-type: none"> Edison Copper Winding No. 15 GOST 6651-2009 / OIML R84:2003
Type of connection	2-wire, 3-wire or 4-wire
Line resistance per wire	Max. 50 Ω
Input current	< 0.15 mA
Effect of the line resistance (with 3-wire and 4-wire connections)	< 0.002 Ω/Ω
Cable, wire-wire capacity	
• Pt1000, Pt10000 (IEC 60751 and JIS C 1604-8)	Max. 30 nF
• All other input types	Max. 50 nF
Fault detection, programmable	None, short-circuited, defective, short-circuited or defective
	Note
	When the low limit for the configured input type is below the constant detection limit for short-circuited inputs, the detection of short circuits is disabled regardless of the configuration of the fault detection.
Detection limit for short-circuited input	15 Ω
Fault detection time (RTD)	≤ 75 ms (typically 70 ms)
Fault detection time (for 3-wire and 4-wire)	≤ 2000 ms

Thermocouples (TC)

Input type	
• B	IEC 60584-1
• E	IEC 60584-1
• J	IEC 60584-1
• K	IEC 60584-1
• L	DIN 43710
• Lr	GOST 3044-84
• N	IEC 60584-1
• R	IEC 60584-1
• S	IEC 60584-1
• T	IEC 60584-1
• U	DIN 43710
• W3	ASTM E988-96
• W5	ASTM E988-96
• LR	GOST 3044-84
Cold junction compensation (CJC)	Constant, internal or external over Pt100 or Ni100 RTD
• Temperature range internal CJC	-50 ... +100 °C (-+58 ... +212 °F)
• Connection external CJC	2-wire, 3-wire or 4-wire
• External CJC, line resistance per wire (for 3-wire and 4-wire connections)	50 Ω
• Effect of the line resistance (with 3-wire and 4-wire connections)	< 0.002 Ω/Ω
• Input current external CJC	< 0.15 mA
• Temperature range external CJC	-50 ... +135 °C (-58 ... +275 °F)
• Cable, wire-wire capacity	Max. 50 nF
• Total line resistance	Max. 10 kΩ
• Fault detection, programmable	None, short-circuited, defective, short-circuited or defective
	Note
	The short-circuited fault detection only applies to the CJC input.
• Fault detection time (TC)	≤ 75 ms (typically 70 ms)
• Fault detection time, external CJC (for 3-wire and 4-wire)	≤ 2000 ms

Linear resistance

Input range	0 ... 100 kΩ
Minimum measuring span	25 Ω
Type of connection	2-wire, 3-wire or 4-wire
Line resistance per wire	Max. 50 Ω
Input current	< 0.15 mA
Effect of the line resistance (with 3-wire and 4-wire connections)	< 0.002 Ω/Ω
Cable, wire-wire capacity	
• R > 400 Ω	Max. 30 nF
• R ≤ 400 Ω	Max. 50 nF
Fault detection, programmable	None, defective
Potentiometers	
Input range	0 ... 100 kΩ
Minimum measuring span	25 Ω
Type of connection	3-wire, 4-wire or 5-wire
Line resistance per wire	Max. 50 Ω
Input current	< 0.15 mA
Effect of the line resistance (with 4-wire and 5-wire connections)	< 0.002 Ω/Ω
Cable, wire-wire capacity	
• R > 400 Ω	Max. 30 nF
• R ≤ 400 Ω	Max. 50 nF

Temperature Measurement Transmitters for rail mounting

SITRANS TR420, two-wire system, HART

Fault detection, programmable	None, short-circuited, defective, short-circuited or defective Note When the configured potentiometer size is below the constant detection limit for short-circuited inputs, the detection of short circuits is disabled regardless of the configuration of the fault detection.
Detection limit for short-circuited input	15 Ω
Fault detection time, wiper arm (no short-circuit detection)	≤ 75 ms (typically 70 ms)
Fault detection time, element	≤ 2000 ms
Fault detection time (for 4-wire and 5-wire)	≤ 2000 ms
Voltage input	
Measuring range	
• Unipolar	-100 ... 1700 mV
• Bipolar	-800 ... +800 mV
Minimum measuring span	2.5 mV
Input resistance	10 MΩ
Cable, wire-wire capacity	
• Input range: -100 ... 1700 mV	Max. 30 nF
• Input range: -20 ... 100 mV	Max. 50 nF
Fault detection, programmable	None, defective
Fault detection time	≤ 75 ms (typically 70 ms)
Output and HART communication	
Normal range, programmable	3.8 ... 20.5 mA/20.5 ... 3.8 mA
Extended range (output limits), programmable	3.5 ... 23 mA/23 ... 3.5 mA
Programmable input/output limits	
• Fault current	Enable/disable
• Fault current setting	3.5 ... 23 mA
Update time	10 ms
Load (with current output)	≤ (V _{Supply} - 7.5)/0.023 Ω
Load stability	< 0.01% of meas. span/100 Ω (measuring span = currently selected range)
Input fault detection, programmable (detection of input short circuits is ignored with TC and voltage inputs)	3.5 ... 23 mA
NAMUR NE43 Upscale	> 21 mA
NAMUR NE43 Downscale	< 3.6 mA
HART protocol versions	HART 7
Measuring accuracy	
Input accuracy	See "Input accuracy" table
Output accuracy	See "Output accuracy" table
Rated conditions	
Ambient temperature (operation)	
• Standard	-50 ... +85 °C (-58 ... +185 °F)
• SIL	-40 ... +80 °C (-40 ... +176 °F)
Storage temperature	-50 ... +85 °C (-58 ... +185 °F)
Calibration temperature	24 °C ±1.0 °C (75.2 °F ±1.8 °F)
Relative humidity	< 99% (no condensation)
Degree of protection	
• Enclosure of the transmitter	IP20
• Terminals	IP20

Design	
Weight	122 g (0.27 lb)
Maximum cable cross-section	2.5 mm ² (AWG 13)
Tightening torque for clamping screws	0.5 ... 0.6 Nm
Vibrations	IEC 60068-2-6
• 2 ... 25 Hz	± 1.6 mm (0.07 inch)
• 25 ... 100 Hz	± 4 g
Certificates and approvals	
<u>Explosion protection ATEX/IECEx and others</u>	
Certificates ³⁾	DEKRA 17ATEX0116 X IECEx DEK 17.0054X A5E43700604A-2018X
"Intrinsic safety ia/ib" type of protection	For use in Zone 0, 1, 2, 20, 21, 22
• ATEX	II 1 G Ex ia IIC T6 ... T4 Ga II 2(1) G Ex ib [ia Ga] IIC T6 ... T4 Gb II 1 D Ex ia IIIC Da I M1 Ex ia I Ma Ex ia IIC T6 ... T4 Ga Ex ib [ia Ga] IIC T6 ... T4 Gb Ex ia IIIC Da Ex ia I Ma
• IECEx and others	Ex ia IIC T6 ... T4 Ga Ex ib [ia Ga] IIC T6 ... T4 Gb Ex ia IIIC Da Ex ia I Ma
"Intrinsic safety ic" type of protection	For use in Zones 2 and 22
• ATEX	II 2 G Ex ic IIC T6...T4 Gc II 2 D Ex ic IIIC Dc
• IECEx and others	Ex ic IIC T6 ... T4 Gc Ex ic IIIC Dc
"Non-sparking/increased safety nA/ec" type of protection	For use in Zones 2 and 22
• ATEX	II 2 G Ex nA IIC T6...T4 Gc II 2 G Ex ec IIC T6...T4 Gc
• IECEx and others	Ex nA IIC T6 ... T4 Gc Ex ec IIC T6 ... T4 Gc
<u>Explosion protection CSA /FM for Canada and USA</u>	
Certificates	CSA 1861385 FM18CA0024 FM18US0046
"Intrinsic safety ia" type of protection	IS, CL I, Div 1, GP ABCD, T6 ... T4 Ex ia IIC T6 ... T4 Ga AEx ia IIC T6 ... T4 Ga or: Ex ib [ia Ga] IIC T6...T4 Gb AEx ib [ia Ga] IIC T6...T4 Gb
"Non incensive field wiring NIFW" type of protection	NIFW, CL I, Div 2, GP ABCD T6 ... T4
"Non incensive NI" type of protection	NI, CL I, Div 2, GP ABCD T6...T4 Ex nA IIC T6 ... T4 Gc AEx nA IIC T6 ... T4 Gc

- Note that the minimum supply voltage must correspond to the value measured at the terminals of the SITRANS TR420.
All external voltage drops must be taken into consideration.
- Protect the device from overvoltage with the help of a suitable power supply or suitable overvoltage protection equipment.
- Additional available certificates are listed on the Internet at <http://www.siemens.com/processinstrumentation/certificates>

Temperature Measurement

Transmitters for rail mounting

SITRANS TR420, two-wire system, HART

Measuring ranges/Minimum measuring span

RTD

Input type	Standard	Measuring range in °C (°F)	α_0 in °C ⁻¹ (°F ⁻¹)	Minimum measuring span in °C (°F)
Pt10 ... 10000	IEC 60751	-200 ... +850 (-328 ... +1562)	0.003851 (0.002139)	10 (50)
	JIS C 1604-8	-200 ... +649 (-328 ... +1200)	0.003916 (0.002176)	10 (50)
	GOST 6651_2009	-200 ... +850 (-328 ... +1562)	0.003910 (0.002172)	10 (50)
	Callendar-Van Dusen	-200 ... +850 (-328 ... +1562)	-	10 (50)
Ni10 ... 10000	DIN 43760-1987	-60 ... +250 (-76 ... +482)	0.006180 (0.003433)	10 (50)
	GOST 6651-2009 / OIML R84:2003	-60 ... +180 (-76 ... +356)	0.006170 (0.003428)	10 (50)
Cu5 ... 1000	Edison Copper Winding No. 15	-200 ... +260 (-328 ... +500)	0.004270 (0.002372)	100 (212)
	GOST 6651-2009 / OIML R84:2003	-180 ... +200 (-292 ... +392)	0.004280 (0.002378)	100 (212)
	GOST 6651-94	-50 ... +200 (-58 ... +392)	0.004260 (0.002367)	100 (212)

TC

Input type	Standard	Measuring range in °C (°F)	Minimum measuring span in °C (°F)
B	IEC 60584-1	0 (85) ... 1 820 (32 (185) ... 3 308)	100 (212)
E	IEC 60584-1	-200 ... +1 000 (-392 ... +1 832)	50 (122)
J	IEC 60584-1	-100 ... +1200 (-212 ... +2192)	50 (122)
K	IEC 60584-1	-180 ... +1372 (-356 ... +2502)	50 (122)
L	DIN 43710	-200 ... +900 (-392 ... +1652)	50 (122)
Lr	GOST 3044-84	-200 ... +800 (-392 ... +1472)	50 (122)
N	IEC 60584-1	-180 ... +1300 (-356 ... +2372)	50 (122)
R	IEC 60584-1	-50 ... +1760 (-122 ... +3200)	100 (212)
S	IEC 60584-1	-50 ... +1760 (-122 ... +3200)	100 (212)
T	IEC 60584-1	-200 ... +400 (-392 ... +752)	50 (122)
U	DIN 43710	-200 ... +600 (-392 ... +1112)	50 (122)
W3	ASTM E988-96	0 ... 2300 (32 ... 4172)	100 (212)
W5	ASTM E988-96	0 ... 2300 (32 ... 4172)	100 (212)
LR	GOST 3044-84	-200 ... +800 (-392 ... +1472)	50 (122)

Input accuracy

Basic values

Input type	Basic accuracy	Temperature coefficient ¹⁾
RTD		
Pt10	≤ ±0.8 °C (1.44 °F)	≤ ±0.020 °C/°C (°F/°F)
Pt20	≤ ±0.4 °C (0.72 °F)	≤ ±0.010 °C/°C (°F/°F)
Pt50	≤ ±0.16 °C (0.288 °F)	≤ ±0.004 °C/°C (°F/°F)
Pt100	≤ ±0.04 °C (0.072 °F)	≤ ±0.002 °C/°C (°F/°F)
Pt200	≤ ±0.08 °C (0.144 °F)	≤ ±0.002 °C/°C (°F/°F)
Pt500	$T_{\max.} < 180 \text{ °C (356 °F)} = \leq \pm 0.08 \text{ °C (0.144 °F)}$ $T_{\max.} < 180 \text{ °C (356 °F)} = \leq \pm 0.16 \text{ °C (0.288 °F)}$	≤ ±0.002 °C/°C (°F/°F)
Pt1000	≤ ±0.08 °C (0.144 °F)	≤ ±0.002 °C/°C (°F/°F)
Pt2000	$T_{\max.} < 300 \text{ °C (572 °F)} = \leq \pm 0.08 \text{ °C (0.144 °F)}$ $T_{\max.} < 300 \text{ °C (572 °F)} = \leq \pm 0.4 \text{ °C (0.72 °F)}$	≤ ±0.002 °C/°C (°F/°F)
Pt10000	≤ ±0.16 °C (0.288 °F)	≤ ±0.002 °C/°C (°F/°F)
Pt x	Largest tolerance of neighboring points	Largest temperature coefficient of neighboring points
Ni10	≤ ±1.6 °C (2.88 °F)	≤ ±0.020 °C/°C (°F/°F)
Ni20	≤ ±0.8 °C (1.44 °F)	≤ ±0.010 °C/°C (°F/°F)
Ni50	≤ ±0.32 °C (0.576 °F)	≤ ±0.004 °C/°C (°F/°F)
Ni100	≤ ±0.16 °C (0.288 °F)	≤ ±0.002 °C/°C (°F/°F)
Ni120	≤ ±0.16 °C (0.288 °F)	≤ ±0.002 °C/°C (°F/°F)
Ni200	≤ ±0.16 °C (0.288 °F)	≤ ±0.002 °C/°C (°F/°F)
Ni500	≤ ±0.16 °C (0.288 °F)	≤ ±0.002 °C/°C (°F/°F)
Ni1000	≤ ±0.16 °C (0.288 °F)	≤ ±0.002 °C/°C (°F/°F)
Ni2000	≤ ±0.16 °C (0.288 °F)	≤ ±0.002 °C/°C (°F/°F)

Temperature Measurement Transmitters for rail mounting

SITRANS TR420, two-wire system, HART

Input type	Basic accuracy	Temperature coefficient ¹⁾
Ni10000	≤ ±0.32 °C (0.576 °F)	≤ ±0.002 °C/°C (°F/°F)
Ni x	Largest tolerance of neighboring points	Largest temperature coefficient of neighboring points
Cu5	≤ ±1.6 °C (2.88 °F)	≤ ±0.040 °C/°C (°F/°F)
Cu10	≤ ±0.8 °C (1.44 °F)	≤ ±0.020 °C/°C (°F/°F)
Cu20	≤ ±0.4 °C (0.72 °F)	≤ ±0.010 °C/°C (°F/°F)
Cu50	≤ ±0.16 °C (0.288 °F)	≤ ±0.004 °C/°C (°F/°F)
Cu100	≤ ±0.08 °C (0.144 °F)	≤ ±0.002 °C/°C (°F/°F)
Cu200	≤ ±0.08 °C (0.144 °F)	≤ ±0.002 °C/°C (°F/°F)
Cu500	≤ ±0.16 °C (0.288 °F)	≤ ±0.002 °C/°C (°F/°F)
Cu1000	≤ ±0.08 °C (0.144 °F)	≤ ±0.002 °C/°C (°F/°F)
Cu x	Largest tolerance of neighboring points	Largest temperature coefficient of neighboring points
Linear resistance		
0 ... 400 Ω	≤ ±40 mΩ	≤ ±2 mΩ/°C (1.11 mΩ/°F)
0 ... 100 kΩ	≤ ±4 Ω	≤ ±0.2 Ω/°C (0.11 Ω/°F)
Potentiometers		
0 ... 100%	< 0.05%	< ± 0.005%
Voltage input		
mV: -20 ... 100 mV	≤ ±5 μV	≤ ±0.2 μV/°C (0.11 μV/°F)
mV: -100 ... 1700 mV	≤ ±0.1 mV	≤ ±36 μV/°C (20 μV/°F)
mV: ± 800 mV	≤ ±0.1 mV	≤ ±32 μV/°C (17.8 μV/°F)
TC		
E	≤ ±0.2 °C (0.36 °F)	≤ ±0.025 °C/°C (°F/°F)
J	≤ ±0.25 °C (0.45 °F)	≤ ±0.025 °C/°C (°F/°F)
K	≤ ±0.25 °C (0.45 °F)	≤ ±0.025 °C/°C (°F/°F)
L	≤ ±0.35 °C (0.63 °F)	≤ ±0.025 °C/°C (°F/°F)
N	≤ ±0.4 °C (0.72 °F)	≤ ±0.025 °C/°C (°F/°F)
T	≤ ±0.25 °C (0.45 °F)	≤ ±0.025 °C/°C (°F/°F)
U	< 0 °C (32 °F) ≤ ±0.8 °C (1.44 °F) ≥ 0 °C (32 °F) ≤ ±0.4 °C (0.72 °F)	≤ ±0.025 °C/°C (°F/°F)
Lr	≤ ±0.2 °C (0.36 °F)	≤ ±0.1 °C/°C (°F/°F)
R	< 200 °C (392 °F) ≤ ±0.5 °C (0.9 °F) ≥ 200 °C (392 °F) ≤ ±1 °C (1.8 °F)	≤ ±0.1 °C/°C (°F/°F)
S	< 200 °C (392 °F) ≤ ±0.5 °C (0.9 °F) ≥ 200 °C (392 °F) ≤ ±1 °C (1.8 °F)	≤ ±0.1 °C/°C (°F/°F)
W3	≤ ±0.6 °C (1.08 °F)	≤ ±0.1 °C/°C (°F/°F)
W5	≤ ±0.4 °C (0.72 °F)	≤ ±0.1 °C/°C (°F/°F)
B ²⁾	≤ ±1 °C (1.8 °F)	≤ ±0.1 °C/°C (°F/°F)
B ³⁾	≤ ±3 °C (5.4 °F)	≤ ±0.1 °C/°C (°F/°F)
B ⁴⁾	≤ ±8 °C (14.4 °F)	≤ ±0.8 °C/°C (°F/°F)
B ⁵⁾	Not specified	Not specified
CJC (internal)	≤ ±0.5 °C (0.9 °F)	Included in basic accuracy
CJC (external)	≤ ±0.08 °C (0.144 °F)	≤ ±0.002 °C/°C (°F/°F)

1) Temperature coefficients correspond to the specified values or 0.002% of the input span, depending on which value is greater.

2) 2) Accuracy of the specification range > 400 °C (752 °F)

3) 3) Accuracy of the specification range > 160 °C (320 °F) < 400 °C (752 °F)

4) 4) Accuracy of the specification range > 85 °C (185 °F) < 160 °C (320 °F)

5) 5) Accuracy of the specification range > 85 °C (185 °F)

Output accuracy

Output type	Basic accuracy	Temperature coefficient
Average value measurement	Average of accuracy of input 1 and input 2	Average of temperature coefficient of input 1 and input 2
Differential measurement	Sum of accuracy of input 1 and input 2	Sum of temperature coefficient of input 1 and input 2
Analog output	≤ ±1.6 μA (0.01% of the full output span)	≤ ±0.48 μA/K (≤ ±0.003% of the full output span/K)

Temperature Measurement Transmitters for rail mounting

SITRANS TR420, two-wire system, HART

Selection and ordering data

2

	Article No.		Order code
Temperature transmitter SITRANS TR420 with 2 inputs	7NG042		
Click on the Article no. for the online configuration in the PIA Life Cycle Portal.			
Communication			
With HART	0		
Primary value output			
Input 1	0		
Input 1, input 2 as redundancy	1		
Input 2, input 1 as redundancy	2		
Average input 1 and input 2, both as redundancy	3		
Minimum input 1 and input 2, both as redundancy	4		
Maximum input 1 and input 2, both as redundancy	5		
Difference input 1 - input 2	6		
Difference input 2 - input 1	7		
Absolute difference	8		
Primary value output, customer-specific			
Minimum input 1 and input 2, without redundancy	9		H 1 A
Maximum input 1 and input 2, without redundancy	9		H 1 B
Average input 1 and input 2, without redundancy	9		H 1 C
Input 2	9		H 1 D
Input 1, type			
RTD			
• Pt100 (IEC), 3-wire	B		
• Pt100 (IEC), 4-wire	C		
• Pt1000 (IEC), 3-wire	D		
• Pt1000 (IEC), 4-wire	E		
TC			
• Type B	F		
• Type E	G		
• Type J	H		
• Type K	J		
• Type L	K		
• Type N	L		
• Type R	N		
• Type S	P		
• Type T	Q		
Potentiometer, 4-wire	R		
Input 1, type customer-specific			
Define customer-specific input configurations in V options	Y		

	Article No.		Order code
Temperature transmitter SITRANS TR420 with 2 inputs	7NG042		
Click on the Article no. for the online configuration in the PIA Life Cycle Portal.			
Input 2, type			
Without input 2	A		
RTD			
• Pt100 (IEC), 3-wire	B		
• Pt100 (IEC), 4-wire	C		
• Pt1000 (IEC), 3-wire	D		
• Pt1000 (IEC), 4-wire	E		
TC			
• Type B	F		
• Type E	G		
• Type J	H		
• Type K	J		
• Type L	K		
• Type N	L		
• Type R	N		
• Type S	P		
• Type T	Q		
Potentiometer, 4-wire	R		
Input 2, type customer-specific			
Define customer-specific input configurations in W options	Y		
CJC configuration for TC			
Input 1: no CJC; input 2: no CJC	0		
Input 1: internal CJC; input 2: internal CJC	1		
Input 1: external CJC; input 2: external CJC; define type in option Jxx	2		
Input 1: external CJC; define type in option Jxx; input 2: internal CJC	3		
Input 1: internal CJC; input 2: external CJC; define type in option Jxx	4		
Input 1: Internal CJC; Input 2: No CJC	5		
Input 1: External CJC (define type in option Jxx); input 2: No CJC	6		
Materials not in contact with media			
None	0		
Type of protection			
General safety (non-Ex); CE, RCM, FM, CSA, KCC	A		
Ex i, Ex nA (ec) (Zone)/IS, NIFW, NI (Division); ATEX, IECEx, CSA, FM, NEPSI	N		
Electrical connection / cable entry			
None	A		
Local HMI			
Without display	0		

Selection and ordering data

Options	Order code
Add "-Z" to article no. and specify order code.	
Certificates for functional safety	
Functional safety SIL2/3 (IEC 61508)	C20
Special features of enclosure/packaging	
Without labeling of the measuring range on the TAG label	D41
External CJC types	
Pt100, IEC 60751, 3-wire	J02
Pt100, IEC 60751, 4-wire	J03
Ni100, DIN 43760-87, 3-wire	J05
Ni100, DIN 43760-87, 4-wire	J06
Input 1: TC	
Type C W5	V01
Type D W3	V02
Type U	V03
Type Lr	V04
Input 1: Potentiometers	
Potentiometer, 5-wire	V31
Input 1: RTD	
Pt x (IEC), 3-wire, define RTD factor x in option Y21	V61
Pt x (IEC), 4-wire, define RTD factor x in option Y21	V62
Pt x (JIS C1604-81), 3-wire, define RTD factor x in option Y21	V64
Pt x (JIS C1604-81), 4-wire, define RTD factor x in option Y21	V65
Pt x (GOST 6651-2009), 3-wire, define RTD factor x in option Y21	V67
Pt x (GOST 6651-2009), 4-wire, define RTD factor x in option Y21	V68
Ni x (DIN 43760-87), 3-wire, define RTD factor x in option Y21	V70
Ni x (DIN 43760-87), 4-wire, define RTD factor x in option Y21	V71
Ni x (GOST 6651-2009), 3-wire, define RTD factor x in option Y21	V73
Ni x (GOST 6651-2009), 4-wire, define RTD factor x in option Y21	V74
Cu x (ECW-15), 3-wire, define RTD factor x in option Y21	V76
Cu x (ECW-15), 4-wire, define RTD factor x in option Y21	V77
Cu x (GOST 6651-94), 3-wire, define RTD factor x in option Y21	V79
Cu x (GOST 6651-94), 4-wire, define RTD factor x in option Y21	V80
Cu x (GOST 6651-2009), 3-wire, define RTD factor x in option Y21	V82
Cu x (GOST 6651-2009), 4-wire, define RTD factor x in option Y21	V83
Input 2: TC	
Type C W5	W01
Type D W3	W02
Type U	W03
Type Lr	W04

Customer-specific device settings	Order code
Add "-Z" to article no., specify order code and plain text or drop-down list selection.	
Measuring range setting temperature input: Start of scale value (max. 5 characters), full scale value (max. 5 characters), unit (°C, °F, °Ra, K)	Y01
Plant designation (TAG, device parameters, max. 32 characters)	Y15
Measuring point message (device message and device parameters, max. 32 characters)	Y16
Plant designation short (TAG, device parameters, max. 8 characters) on front plate, only for SITRANS TR320/SITRANS TR420	Y19
Input 1: RTD factor; e.g. factor "200" = Pt200	Y21
Accessories	Article No.
Further accessories for assembly, connection and transmitter configuration, see page 2/238.	
HART modem	7MF4997-1DB
With USB interface	
SIMATIC PDM parameterization software	See Catalog FI 01 section 8

Ordering example

7NG0420-0BA00-0AA0-Z Y01

Y01: -10 ... +100 °C

Factory setting

- Input 1: Pt100 (IEC 751); 3-wire connection
- Input 2: not configured (inactive)
- Measuring range: 0 ... 100 °C (32 ... 212 °F)
- Fault current
 - Device error: < 3.6 mA
 - Input circuit wire break: 22.8 mA
 - Input circuit short circuit: 22.4 mA
 - Input circuit drift: 22 mA (active when input 2 is active)
 - Input monitoring wire break and short-circuit
- No trimming of input and output (offset)
- Damping 0.0 s

Temperature Measurement

Transmitters for rail mounting

SITRANS TR420, two-wire system, HART

Dimensional drawings

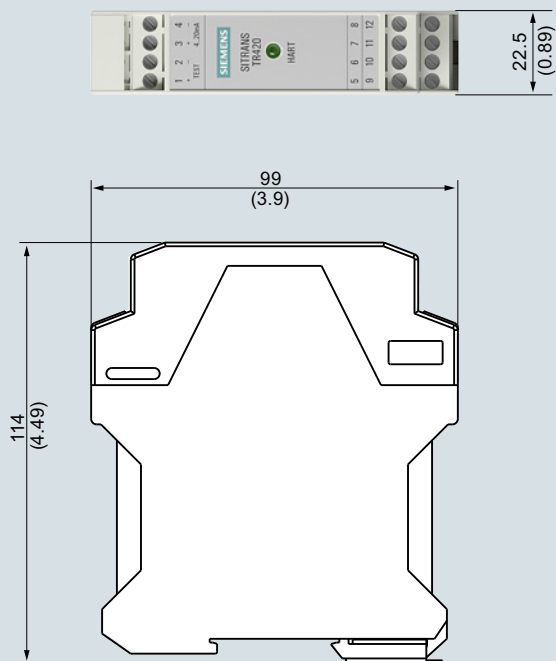

SITRANS TR420, dimensions in mm (inch)

Circuit diagrams

Connections

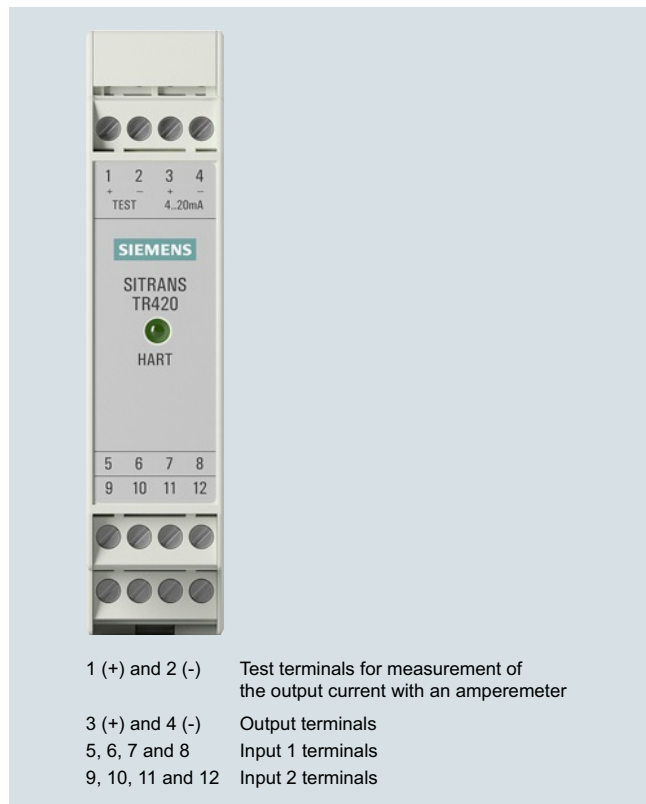

SITRANS TR420, connector assignment

Output and test connection

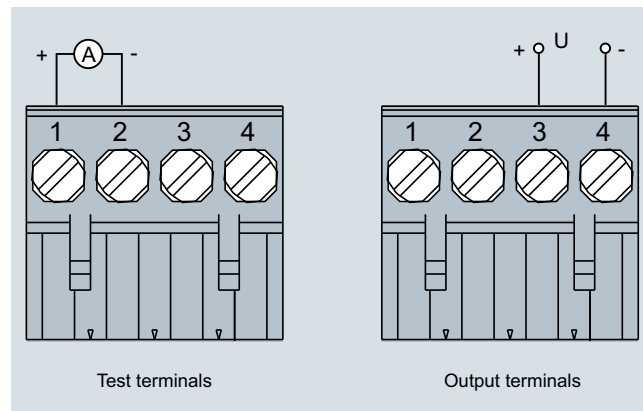

SITRANS TR420, output connection assignment

Input connection

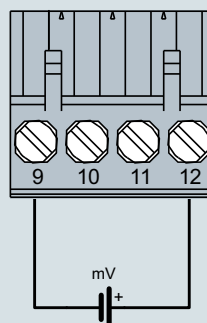
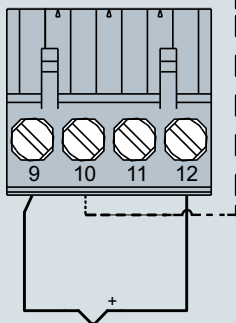
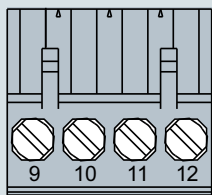
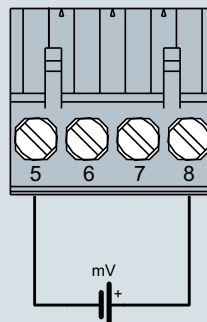
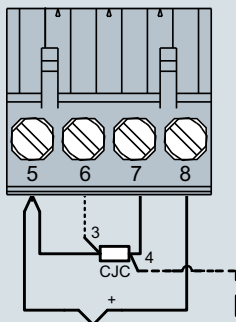
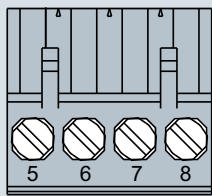

Input 1 and/or input 2:
2-wire, 3-wire or 4-wire
RTD or linear resistance

Input 1 and/or input 2:
TC (int. CJC or
external 2-wire or 3-wire CJC)

Voltage input
(unipolar or bipolar)

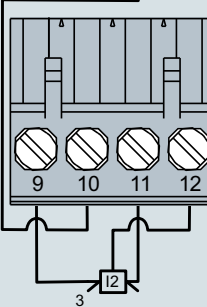
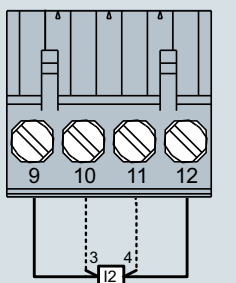
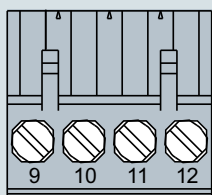
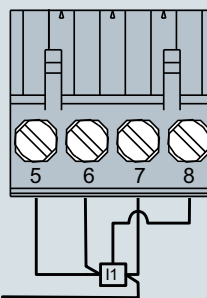
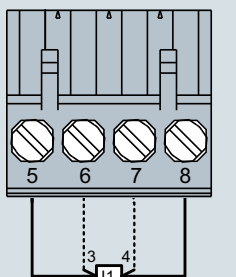
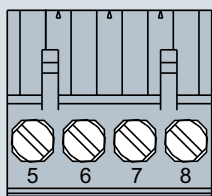

Input 1:
TC (int. CJC or
external 2-wire or 3-wire CJC)
Input 2:
2-wire, 3-wire or 4-wire RTD

Input 1 (I1) and/or input 2 (I2):
3-wire or 4-wire potentiometer

Input 1 (I1):
5-wire potentiometer
Input 2 (I2):
3-wire potentiometer

SITRANS TR420, input connection assignment